



LED NEON FLEX SPECIFICATION

Uneon UNS-SIDE-1220-W40-15-CC



- Regular power 5W/m, 10W/m and 15W/m for option
- Max length 35 meters with one end power
- Soldering-free and silicone end cap
- Eight CCT optional from 2100K to 6150K



Dimensions & Waterproof

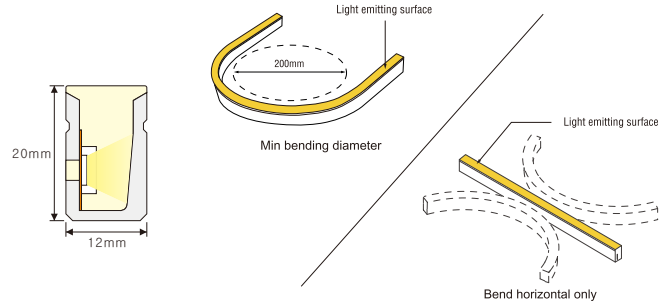
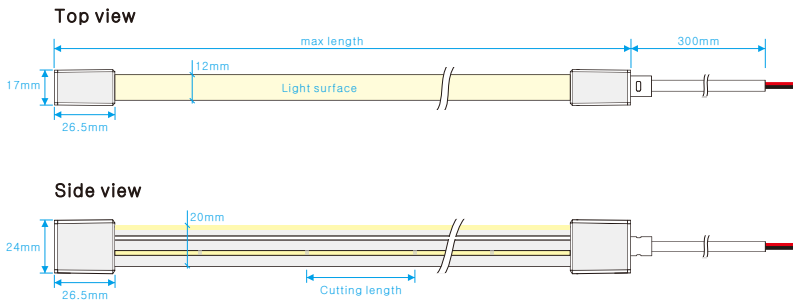

Product specification

Voltage	DC24 V
CRI/Ra	>90
Ambient temperature	-25°C~45°C
Color Type	Cutting length(mm)
Single color	50mm
Tunable white	50mm
RGB color	CV: 62.5mm / CC: 125mm
RGBW color	CV: 62.5mm / CC: 125mm

Note: CV means Constant Voltage, CC means Constant Current.

Polar curve (The data base on 15W 6000K)

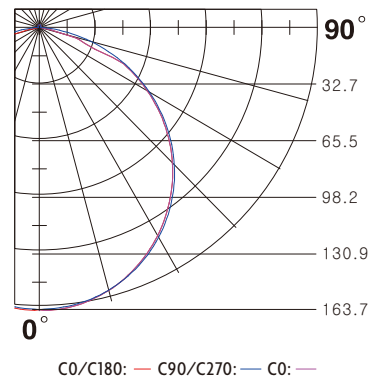

White color parameters

Part Number	CCT (K)	Low power(5w/m)		Medium power(10w/m)		High power(15w/m)	
		(lm/m)	(max length)	(lm/m)	(max length)	(lm/m)	(max length)
▶ UNS-SIDE-1220-W21	2000-2200K	131.7	27m	258.7	17m	360.9	14m
▶ UNS-SIDE-1220-W24	2300-2500K	150.4	27m	293.0	17m	410.1	14m
▶ UNS-SIDE-1220-W27	2600-2800K	152.7	27m	303.2	17m	431.7	14m
▶ UNS-SIDE-1220-W30	2900-3100K	156.7	27m	307.2	17m	432.3	14m
▶ UNS-SIDE-1220-W35	3400-3700K	176.9	27m	345.1	17m	475.4	14m
▶ UNS-SIDE-1220-W40	3800-4300K	170.1	27m	335.6	17m	470.1	14m
▶ UNS-SIDE-1220-W50	4800-5300K	170.0	27m	329.4	17m	461.8	14m
▶ UNS-SIDE-1220-W60	5900-6400K	168.2	27m	328.3	17m	465.1	14m

Tunable color parameters

Part Number	CCT (K)	Low power(5w/m)		Medium power(10w/m)		High power(15w/m)	
		(lm/m)	(max length)	(lm/m)	(max length)	(lm/m)	(max length)
▶ UNS-SIDE-1220-TW	2500-2900K	80.2	5m	171.3	5m	229.0	5m
▶ UNS-SIDE-1220-TW	5000-5800K	85.6	5m	186.0	5m	244.3	5m
▶ UNS-SIDE-1220-TW	3500-4200K	167.4	5m	353.5	5m	476.3	5m

RGB & RGBW color parameters

Part Number	Color (nm)	Low power(5w/m)		Medium power(10w/m)		High power(15w/m)	
		(lm/m)	(max length)	(lm/m)	(max length)	(lm/m)	(max length)
▶ UNS-SIDE-1220-R	Red(620-625nm)	73.8	35m	155.4	23m	204.7	18m
▶ UNS-SIDE-1220-G	Green(515-525nm)	198.2	27m	372.6	17m	473.2	14m
▶ UNS-SIDE-1220-B	Blue(460-465nm)	35.2	27m	69.8	17m	93.3	14m
▶ UNS-SIDE-1220-Y	Yellow(585-595nm)	15.5	35m	30.4	23m	40.8	18m
▶ UNS-SIDE-1220-P	Pink	74.6	27m	148.2	17m	199	14m
▶ UNS-SIDE-1220-RGB-CV	RGB	86.1	5m	160.2	5m	200.3	5m
▶ UNS-SIDE-1220-RGBW-CV	RGBW	110.7	5m	211.2	5m	301.8	5m
▶ UNS-SIDE-1220-RGB-CC	RGB:200lm/m	R:41lm/m G:140lm/m B:23lm/m				Max length 13m	
▶ UNS-SIDE-1220-RGBW-CC	RGBW:308lm/m	R:35.8lm/m G:107lm/m B:33.6lm/m W: 14lm/m				Max length 10m	

Note: CV means Constant Voltage, CC means Constant Current.

Installation of solder-free connector with cable

Explosive drawing of Solder-free connector with cable

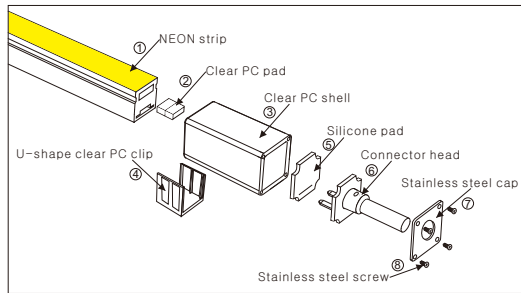

Cable outlet

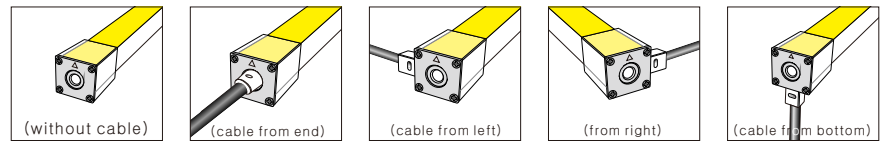

Note:

1. The same installation step suit for different outlet cable of the connector
2. Please keep the cutting place as flat as possible to achieve better waterproof effect.
3. This installation instruction is suitable of all the solder-free connector with similar structures.

Installation instruction of Solder-free connector with cable

Step 1:
Insert the clear PC pad into the hole of the NEON strip

Step 2:
Insert NEON strip into the clear PC shell

Step 3:
Install the U-shape clear PC clip on the bottom

Step 4:
Insert the connector head into the silicone pad

Step 5:
Insert the connector head into the NEON strip, please make sure the connector plug on the back of PCB soldering spot

Step 6:
Use screws to fix the stainless steel cap on the clear PC shell

Step 7:
Finish the whole installation of NEON strip end cap with cable

Installation of solder-free connector without cable

Explosive drawing of Solder-free connector without cable

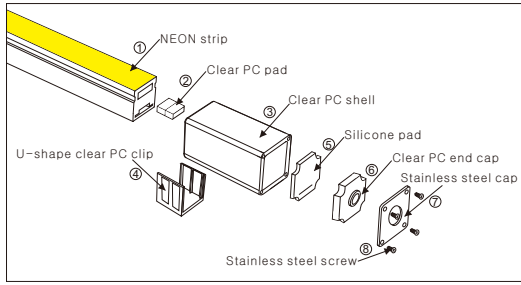

Installation instruction of Solder-free connector without cable

<p>Step 1: Insert the clear PC pad into the hole of the NEON strip</p>	<p>Step 2: Insert NEON strip into the clear PC shell</p>	<p>Step 3: Install the U-shape clear PC clip on the bottom</p>	<p>Step 4: Press the silicone pad into the Clear PC shell</p>
<p>Step 5: Press the clear PC end cap into the Clear PC shell</p>	<p>Step 6: Use screws to fix the stainless steel cap on the clear PC shell</p>	<p>Step 7: Finish the whole installation of NEON strip end cap without cable</p>	

Accessory



IP65 Solder-free endcap

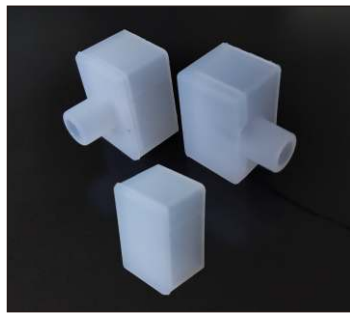

IP67 Silicone end cap

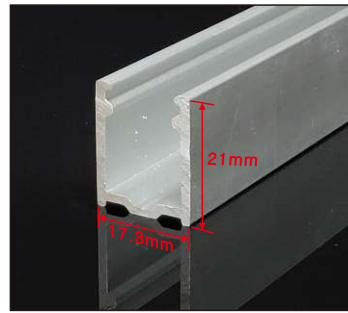

Mounting clip(length: 2cm)
Mounting channel(length: 1m, 2m,3m)



Scissors with angular scale

NOTE: IP65 version, solderless endcap fix by screw, more convenient; IP67 version, silicone endcap fix by silicone glue, more reliable.

Installation

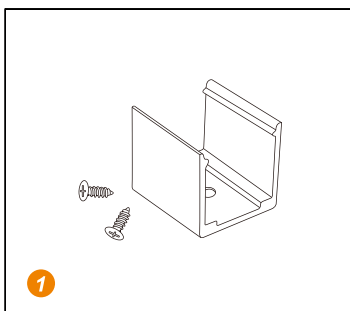

1 Prepare the screws and mounting clips

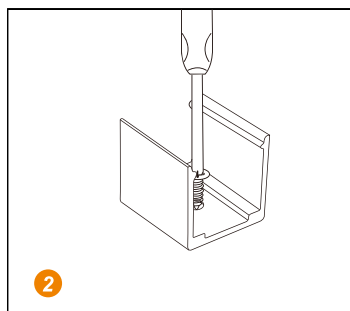

2 Adjust the fixed clips to the appropriate place, use a screwdriver to fix the screw.

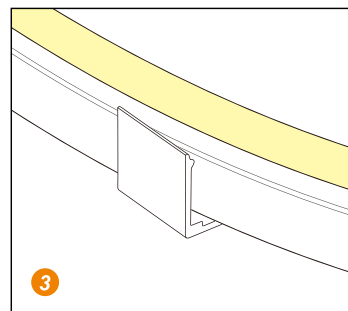

3 Put the light emitting surface upwards, then insert the LED strip into the fixed clips.

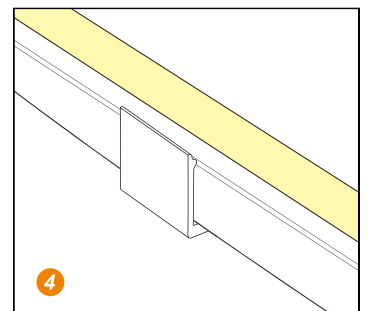

4 Fix NEON strip completely into the fixed clip.