

Tuya APP cloud control / Voice control / AC Motor Control / Push Switch Adjustment Position / Sound Alert

Feature

- Tuya /Smart life APP cloud control, support timing on/off, motor commutation function.
- Connect with two push switch to control curtain on/off position percentage.
- Sound alert: within 3 seconds time, the opening/closing action exceeds 7 times, the curtain switch module issues a sound alert until it is no longer operated.
- Voice control, support for Amazon Alexa, Google Assistant, Tmall Genie and Xiaodu smart speakers.
- Match with RF 2.4G dimming remote control optional.

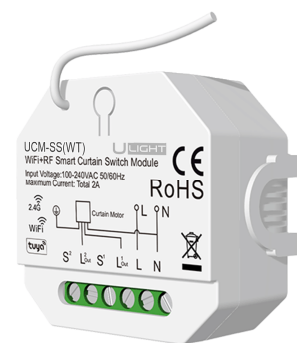

CE RoHS RED

Technical Parameters

Hardware parameters	
Input voltage	100-240VAC 50/60Hz
Output current	Max. 2A(AC)
Output power	200-480W
Input signal	Tuya APP + RF 2.4GHz + Push switch
Control distance	30m(Barrier-free space)

Environment and Warranty	
Operation temperature	Ta: -10°C~ 55°C
Casertemperature(Max.)	Tc: +65°C
Warranty	5 years

Package	
Size	L 56xW56xH35mm
Gross weight	0.066kg

Mechanical Structures and Installations

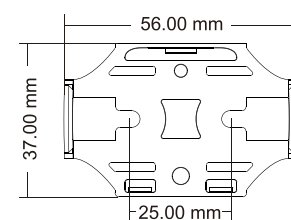
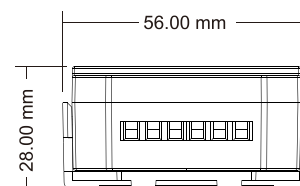
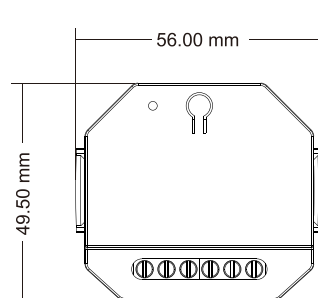
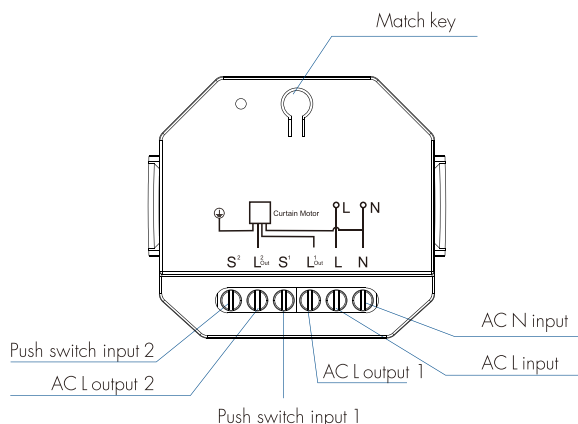

Installation way

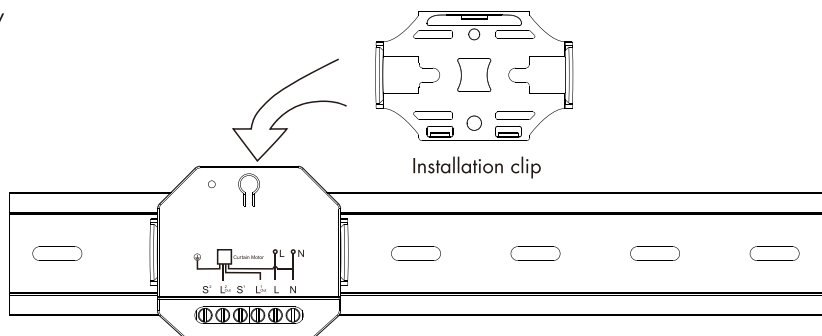

Note:

1. The installation must be installed or removed by a professional electrician.
2. Please keep the device out of the reach of children.
3. Please keep away from water, humid or hot environment.
4. The device should be kept away from strong signal sources (such as microwave ovens) to avoid signal interruption and cause the device not to work properly.
5. Avoid placing the device close to or near high-density materials (such as metal, concrete walls, etc.), which will reduce or block the wireless signal.

Wiring Diagram

- Connect with push switch

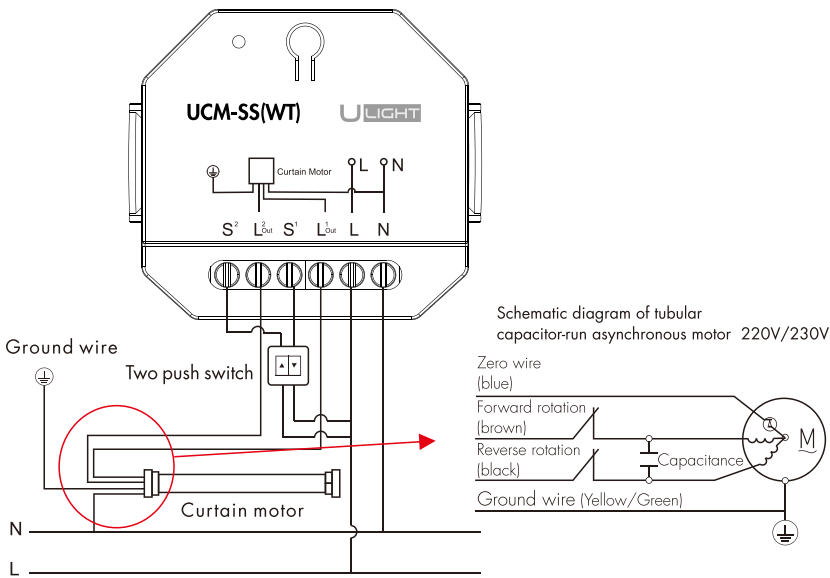

- No push switch connected

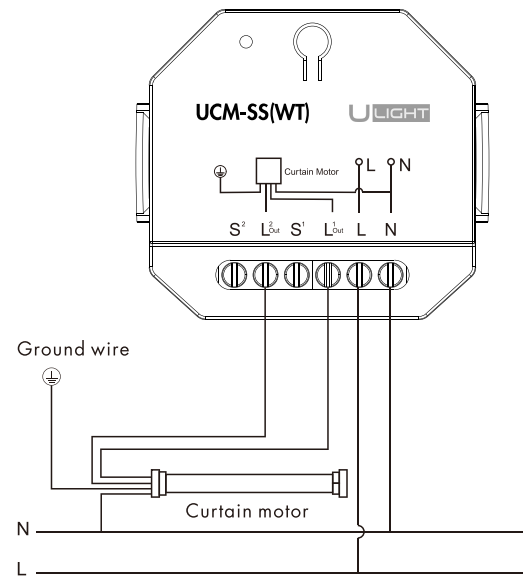

Note: The two push switches control the forward and reverse steering respectively, and the specific forward and reverse direction needs to be decided according to the actual curtain motor wiring.

System wiring

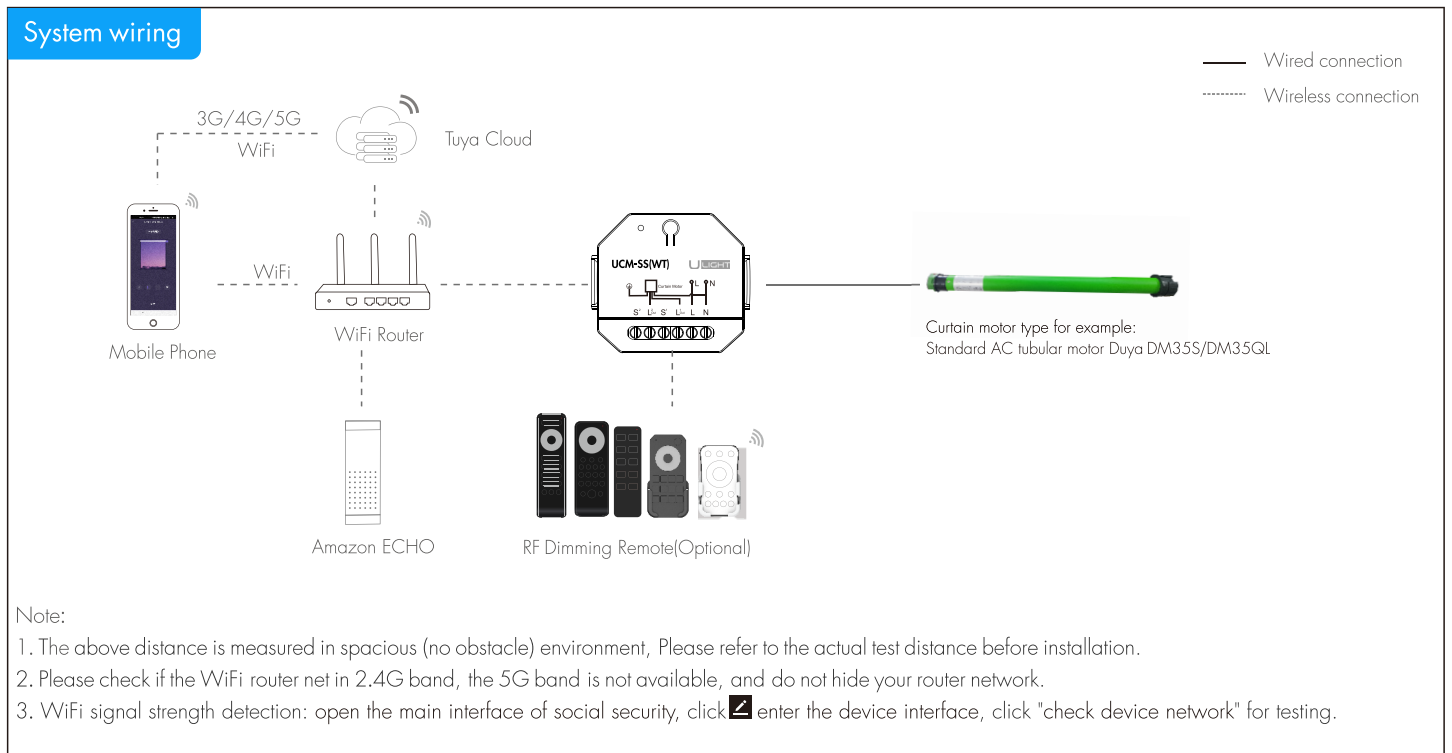

Tuya APP network connection

Please download the corresponding tuya/smart life app according to your region.

Press and hold Match key for 5s, or push twice Match key fastly, or repeat power on and off for 5 consecutive times: Clear previous network connection, enter Smart config mode, the LED indicator flash fastly. Config mode lasts for 30S, and config mode is automatically exited after 30S.



Smart life APP



Tuya Smart

If Tuya APP network connection succeed, the LED indicator will stop flash, and in Tuya APP, you can find the Smart Curtains(WT) device.

Tuya APP interface

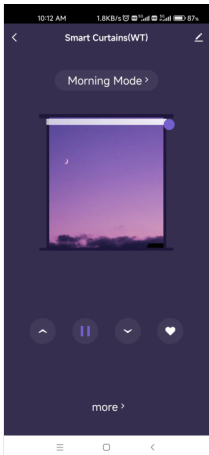

Main interface

Curtain on /off / pause, set the best position (the position percentage of curtains).

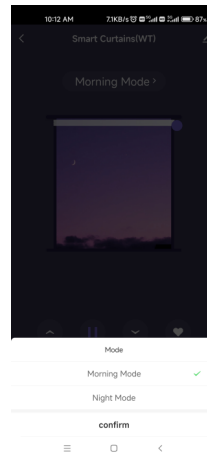

Working mode interface

Morning mode: curtain on
Night mode: curtain off

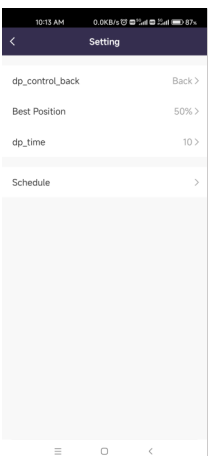

Setting interface

Motor direction:

Default motor positive, 100% curtain full open, reverse, 100% curtain full close.

Best position:

After setting the percentage of ideal position, click the best position in the main interface, the curtain will automatically start to move to the corresponding position.

Travel time:

Set the whole time of curtain opening/closing, the minimum setting is 10 seconds.

Schedule:

Set the curtain to open/close at regular time, or set the curtain to open/close automatically at a fixed time every week.

Match remote control (Optional)

End user can choose the suitable match/delete ways. Two options are offered for selection:

Use the Match key

Match:

Short press match key, immediately press on/off key (single zone remote) or zone key (multiple zone remote) on the remote. The LED indicator fast flash a few times means match is successful.

Delete:

Press and hold match key for 10s, The LED indicator fast flash a few times means all matched remotes were deleted.

Use Power Restart

Match:

Switch off the power, then switch on power, repeat again. Immediately short press on/off key (single zone remote) or zone key (multiple zone remote) 3 times on the remote. The LED indicator blinks 3 times means match is successful.

Delete:

Switch off the power, then switch on power, repeat again. Immediately short press on/off key (single zone remote) or zone key (multiple zone remote) 5 times on the remote. The LED indicator blinks 5 times means all matched remotes were deleted.

Note:

1. Curtain remote control only supports single-zone/multi-zone RF2.4GHz single color dimming remote control series.
2. After the remote control matched successfully, on/off key of single-zone remote controller or on/off key of multi-zone remote controller controls the switch of curtain, brightness adjustment controls the position percentage of the curtain (100% brightness corresponds to full on).
3. Restore factory settings: Long press the match key for 1.5s.

Push Switch Function

The provided Push switch interface allows for a simple curtain switch method using commercially available non-latching (momentary) wall switches or push button. Start the curtain motor forward and reverse by short pressing the left and right button, i.e. open/close the curtain. Short press, the curtain starts to move; short press again, the curtain stops moving.