

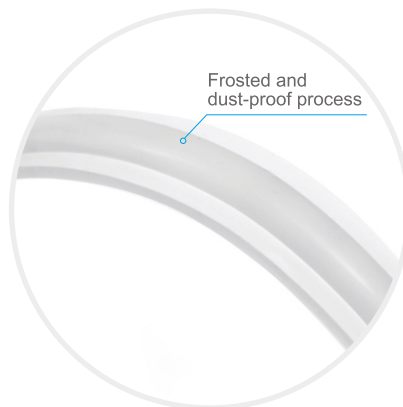

USTRIP DOTLES SPECIFICATION



More extreme vision



More perfect touch

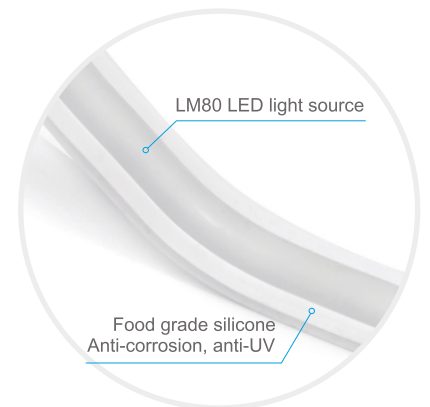

More stable performance

- Slim size, no light spot
- Three-color silicone one-piece extrusion process
- Injection molding plug, IP65 rated
- Frosted, dust-proof process, anti-UV



- 2400K, 2700K, 3000K, 3500K, 4000K, 5000K, 8000K
- 2700K, 6500K

- R (Red), P (Pink), G (Green), B (Blue), Y (Yellow)
- RGE (RGB), BGRW (RGBW), LW (LW)

- One Bin
- CRI > 90
- Solvent resistant
- Saline water resistant
- UV protected
- Cutttable
- 30000 hours Lifetime
- LM80 Compliant
- 3 YEARS WARRANTY

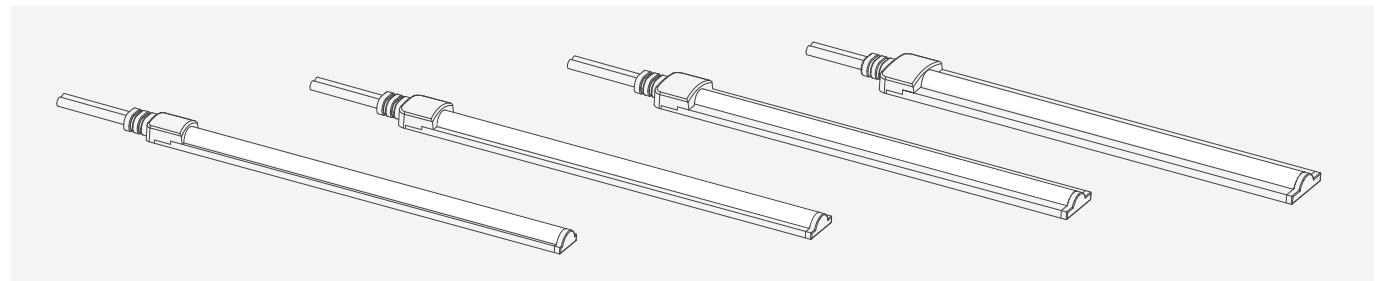

8MM

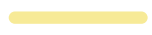

SW

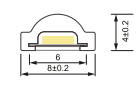

Cross section 8x4mm



W/m: 5 / 10



Max length : 5M



Wire type

10MM



SW | TW | RGB | SPI

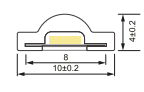

Cross section 10x4mm



W/m: 5 / 10



Max length : 5M

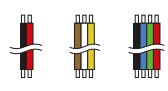

Wire type

12MM



SW | TW | RGB | SPI

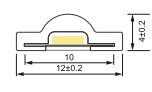

Cross section 12x4mm



W/m: 5 / 10 / 15



Max length : 5M

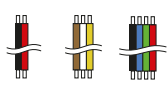

Wire type

14MM



SW | TW | RGB
RGBW | RGBWW | SPI

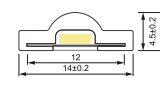

Cross section 14x4.5mm



W/m: 5 / 10 / 15



Max length : 5M



Wire type

Dimensions

8MM

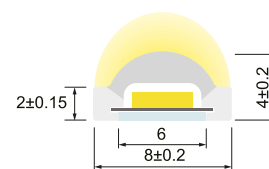
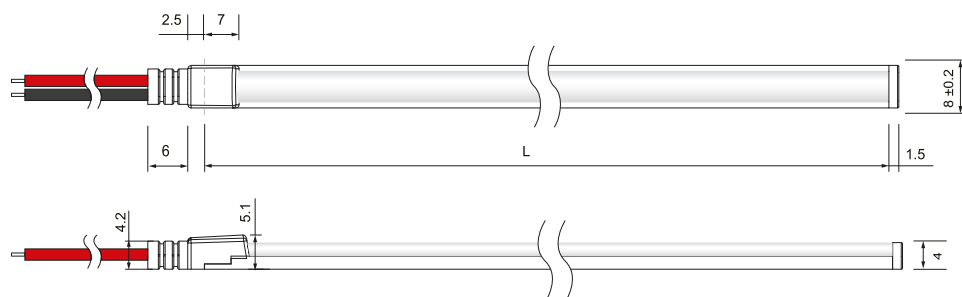

Cross section

10MM

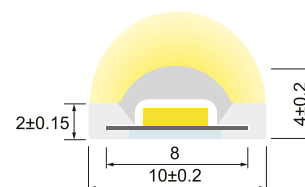

Cross section

12MM

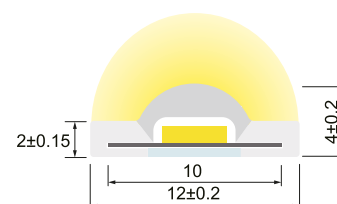
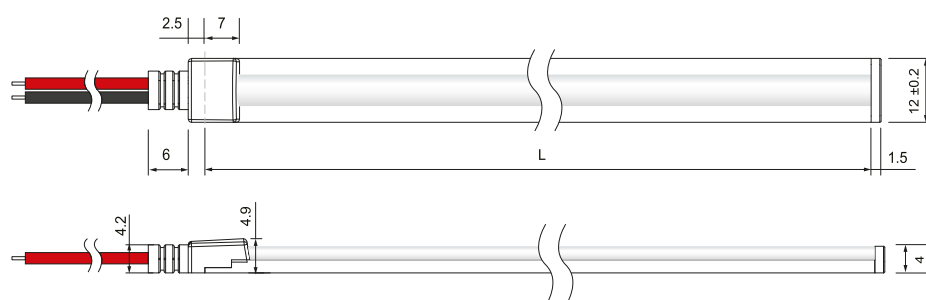

Cross section

14MM

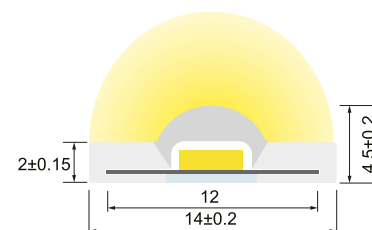
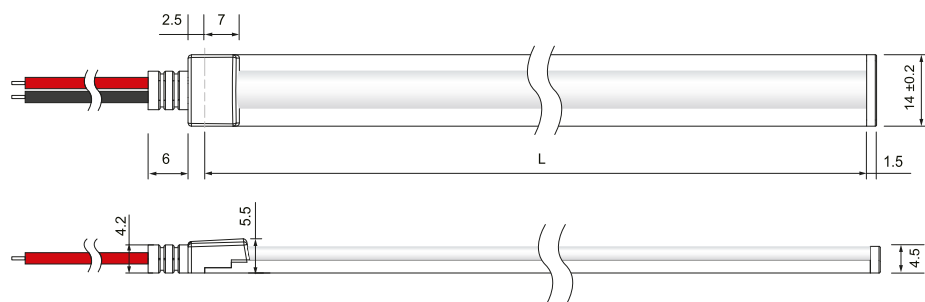

Cross section

8MM Photoelectric parameters

Single Color parameter

CCT (K)	CRI	SDCM	Power	LM/M	LM/W	Cutting length (mm)	Max length (M)	CV/CC
2400	>90	<5	5	535	107.1	50	5	CV
			10	1010	101.0			
2700	>90	<5	5	546	109.2	50	5	CV
			10	1019	101.9			
3000	>90	<5	5	554	110.9	50	5	CV
			10	1046	104.6			
3500	>90	<5	5	599	119.8	50	5	CV
			10	1130	113.0			
4000	>90	<5	5	558	111.7	50	5	CV
			10	1077	107.7			
5000	>90	<5	5	552	110.4	50	5	CV
			10	1028	102.8			
6500	>90	<5	5	560	111.9	50	5	CV
			10	1056	105.6			
R	--	--	5	145	29.0	50	5	CV
			10	293	29.3			
G	--	--	5	381	76.2	50	5	CV
			10	685	68.5			
B	--	--	5	71	14.2	50	5	CV
			10	134	13.4			
Yellow	--	--	5	116	23.2	50	5	CV
			10	223	22.3			
Amber	--	--	5	136	27.2	50	5	CV
			10	274	27.4			
Pink	--	--	5	315	63.0	50	5	CV
			10	602	60.2			

- The above color temperature values are the finished color temperature.
- The above data are typical values. Due to tolerances in the production process, characteristics of electronic components, and other factors, the test parameters will have an error of $\pm 10\%$.
- The maximum serial connection length is for single-ended power input.
- For RGB/RGBW/RGBW/SPI, the maximum connection length refers to the recommended connection length of single-ended power supply when the LED strip is fully loaded. In practical applications, depending on the effect of the controller driving the LED strip, the serial connection can be extended as appropriate in the case of low power.

10MM Photoelectric parameters

Single Color parameter

CCT(K)	CRI	SDCM	Power	LM/M	LM/W	Cutting length (mm)	Max length (M)	CV/CC
2400	>90	<5	5	409	81.9	25	5	CV
			10	815	81.5			
2700	>90	<5	5	423	84.6	25	5	CV
			10	822	82.2			
3000	>90	<5	5	422	84.4	25	5	CV
			10	829	82.9			
3500	>90	<5	5	476	95.2	25	5	CV
			10	918	91.8			
4000	>90	<5	5	439	87.9	25	5	CV
			10	866	86.6			
5000	>90	<5	5	443	88.5	25	5	CV
			10	869	86.9			
6500	>90	<5	5	453	90.6	25	5	CV
			10	886	88.6			
R	--	--	5	146	29.2	25	5	CV
			10	308	30.8			
G	--	--	5	413	82.6	25	5	CV
			10	707	70.7			
B	--	--	5	70	14.0	25	5	CV
			10	137	13.7			
Yellow	--	--	5	106	21.2	25	5	CV
			10	226	22.6			
Amber	--	--	5	128	25.6	25	5	CV
			10	278	27.8			
Pink	--	--	5	287	57.4	25	5	CV
			10	567	56.7			

Tunable White parameter

CCT(K)	CRI	SDCM	Power	LM/M	LM/W	Cutting length (mm)	Max length (M)	CV/CC
2700	>90	<5	5	415	83.0	83.3	5	CV
6500			5	418	83.6			
4000±300			10	826	82.6			

RGB parameter

Power	Color	LM/M	LM/W	Cutting length (mm)	Max length (M)	CV/CC
10	R	60	18.2	50	5	CV
	G	176	53.3			
	B	32	9.7			
	RGB	268	26.8			

10MM Photoelectric parameters

SPI parameter

Input voltage	Power	Color	LM/M	LM/W	Pixel No	Signal Type	IC Model	Cutting length (mm)	Max length (M)
DC5V	8	R	19.8	7.4	100	SPI	UCS1903	10	2
		G	59.3	22.2					
		B	11.5	4.3					
		RGB	87.3	10.9					

- The above color temperature values are the finished color temperature.
- The above data are typical values. Due to tolerances in the production process, characteristics of electronic components, and other factors, the test parameters will have an error of $\pm 10\%$.
- The maximum serial connection length is for single-ended power input.
- For RGB/RGBW/RGBW/SPI, the maximum connection length refers to the recommended connection length of single-ended power supply when the LED strip is fully loaded. In practical applications, depending on the effect of the controller driving the LED strip, the serial connection can be extended as appropriate in the case of low power.

12MM Photoelectric parameters

Single Color parameter

CCT (K)	CRI	SDCM	Power	LM/M	LM/W	Cutting length (mm)	Max length (M)	CV/CC
2400	>90	<5	5	429	85.9	25	5	CV
			10	826	82.6			
			15	1208	80.6			
2700	>90	<5	5	433	86.6	25	5	CV
			10	833	83.3			
			15	1244	82.9			
3000	>90	<5	5	436	87.3	25	5	CV
			10	840	84.0			
			15	1243	82.8			
3500	>90	<5	5	484	96.7	25	5	CV
			10	930	93.0			
			15	1364	91.0			
4000	>90	<5	5	442	88.4	25	5	CV
			10	851	85.1			
			15	1258	83.9			
5000	>90	<5	5	443	88.7	25	5	CV
			10	854	85.4			
			15	1259	84.0			
6500	>90	<5	5	450	90.0	25	5	CV
			10	867	86.7			
			15	1270	84.6			
R	--	--	5	142	28.4	25	5	CV
			10	281	28.1			
			15	416	27.7			
G	--	--	5	349	69.8	25	5	CV
			10	628	62.8			
			15	823	54.9			
B	--	--	5	62	12.4	25	5	CV
			10	121	12.1			
			15	176	11.7			
Yellow	--	--	5	88	17.6	25	5	CV
			10	200	20.0			
			15	294	19.6			
Amber	--	--	5	108	21.6	25	5	CV
			10	246	24.6			
			15	345	23.0			
Pink	--	--	5	274	54.8	25	5	CV
			10	519	51.9			
			15	755	50.3			

12MM Photoelectric parameters

Tunable White parameter

CCT (K)	CRI	SDCM	Power	LM/M	LM/W	Cutting length (mm)	Max length (M)	Input voltage
2700	>90	<5	5	422	84.4	83.3	5	DC24V
6500			5	434	86.8			
4000±300			10	849	84.9			

CCT (K)	CRI	SDCM	Power	LM/M	LM/W	Cutting length (mm)	Max length (M)	Input voltage
2700	>90	<5	7.5	619	82.5	83.3	5	DC24V
6500			7.5	639	85.2			
4000±300			15	1241	82.7			

RGB parameter

Power	Color	LM/M	LM/W	Cutting length (mm)	Max length (M)	Input voltage
10	R	54	16.4	50	5	DC24V
	G	175	53.0			
	B	31	9.4			
	RGB	264	26.4			

Power	Color	LM/M	LM/W	Cutting length (mm)	Max length (M)	Input voltage
15	R	76	15.2	50	5	DC24V
	G	233	46.6			
	B	39	7.8			
	RGB	339	22.6			

SPI parameter

Input voltage	Power	Color	LM/M	LM/W	Pixel No	SignalType	IC Model	Cutting length (mm)	Max length (M)
DC12V	13	R	42.6	3.3	100	SPI	UCS1903	10	3
		G	141.6	10.9					
		B	33	2.5					
		RGB	208.5	16.0					

- The above color temperature values are the finished color temperature.
- The above data are typical values. Due to tolerances in the production process, characteristics of electronic components, and other factors, the test parameters will have an error of ±10%.
- The maximum serial connection length is for single-ended power input.
- For RGB/RGBW/RGBW/SPI, the maximum connection length refers to the recommended connection length of single-ended power supply when the LED strip is fully loaded. In practical applications, depending on the effect of the controller driving the LED strip, the serial connection can be extended as appropriate in the case of low power.

14MM Photoelectric parameters

Single Color parameter

CCT (K)	CRI	SDCM	Power	LM/M	LM/W	Cutting length (mm)	Max length (M)	CV/CC
2400	>90	<5	5	449	89.8	25	5	CV
			10	845	84.5			
			15	1234	82.3			
2700	>90	<5	5	445	89.1	25	5	CV
			10	853	85.3			
			15	1272	84.8			
3000	>90	<5	5	444	88.7	25	5	CV
			10	858	85.8			
			15	1271	84.7			
3500	>90	<5	5	489	97.7	25	5	CV
			10	950	95.0			
			15	1399	93.2			
4000	>90	<5	5	449	89.9	25	5	CV
			10	862	86.2			
			15	1273	84.9			
5000	>90	<5	5	453	90.6	25	5	CV
			10	869	86.9			
			15	1283	85.5			
6500	>90	<5	5	458	91.6	25	5	CV
			10	879	87.9			
			15	1298	86.5			
R	--	--	5	142	28.4	25	5	CV
			10	282	28.2			
			15	420	28.0			
G	--	--	5	375	75.0	25	5	CV
			10	674	67.4			
			15	882	58.8			
B	--	--	5	70	14.0	25	5	CV
			10	123	12.3			
			15	179	11.9			
Yellow	--	--	5	116	23.2	25	5	CV
			10	223	22.3			
			15	318	21.2			
Amber	--	--	5	140	28.0	25	5	CV
			10	274	27.4			
			15	386	25.7			
Pink	--	--	5	287	57.4	25	5	CV
			10	534	53.4			
			15	782	52.1			

14MM Photoelectric parameters

Tunable White parameter

CCT (K)	CRI	SDCM	Power	LM/M	LM/W	Cutting length (mm)	Max length (M)	Input voltage
2700	>90	<5	5	437	87.4	83.3	5	DC24V
6500			5	447	89.4			
4000±300			10	860	86			

CCT (K)	CRI	SDCM	Power	LM/M	LM/W	Cutting length (mm)	Max length (M)	Input voltage
2700	>90	<5	7.5	641	85.5	83.3	5	DC24V
6500			7.5	658	87.7			
4000±300			15	1264	84			

RGB parameter

Power	Color	LM/M	LM/W	Cutting length (mm)	Max length (M)	Input voltage
10	R	49	14.8	50	5	DC24V
	G	169	51.2			
	B	30	9.1			
	RGB	260	26.0			

Power	Color	LM/M	LM/W	Cutting length (mm)	Max length (M)	Input voltage
15	R	69	13.8	50	5	DC24V
	G	226	45.2			
	B	38	7.6			
	RGB	334	22.3			

14MM Photoelectric parameters

RGBW parameter

Power	Color/CCT(K)	CRI	SDCM	Power	LM/M	LM/W	Cutting length (mm)	Max length (M)	Input voltage
15	R	--	--	3	52	17.3	83.33	5	DC24V
	G	--	--	3	156	52.0			
	B	--	--	3	26	8.7			
	W : 2700K	>90	5	6	486	81.0			
	RGBW	--	--	15	702	46.8			
15	R	--	--	3	58	19.3	83.33	5	DC24V
	G	--	--	3	173	57.7			
	B	--	--	3	23	7.7			
	W : 3000K	>90	5	6	480	80.0			
	RGBW	--	--	15	698	46.5			
15	R	--	--	3	56	18.7	83.33	5	DC24V
	G	--	--	3	162	54.0			
	B	--	--	3	32	10.7			
	W : 3500K	>90	5	6	514	85.7			
	RGBW	--	--	15	706	47.1			
15	R	--	--	3	55	18.3	83.33	5	DC24V
	G	--	--	3	158	52.7			
	B	--	--	3	33	11.0			
	W : 4000K	>90	5	6	477	79.5			
	RGBW	--	--	15	701	46.7			
15	R	--	--	3	54	18.0	83.33	5	DC24V
	G	--	--	3	165	55.0			
	B	--	--	3	32	10.7			
	W : 5000K	>90	5	6	487	81.2			
	RGBW	--	--	15	721	48.1			
15	R	--	--	3	52	17.3	83.33	5	DC24V
	G	--	--	3	167	55.7			
	B	--	--	3	32	10.7			
	W : 6500K	>90	5	6	486	81.0			
	RGBW	--	--	15	716	47.7			

RGBTW parameter

Power	Color/CCT(K)	CRI	Power	LM/M	LM/W	Cutting length (mm)	Max length (M)	Input voltage
9	R	--	3	58	19.3	71.4	5	DC24V
	G	--	3	171	57			
	B	--	3	33	11			
	RGB	--	9	248	27.6			
10	2700±100K	>90	5	360	72	71.4	5	DC24V
	5500±300K	>90	5	357	71.4			
	3800K±200K	>90	10	722	72.2			

14MM Photoelectric parameters

SPI parameter

Input voltage	Power	Color	LM/M	LM/W	Pixel No	Signal Type	IC Model	Cutting length (mm)	Max length (M)
DC12V	13	R	44.4	3.4	100	SPI	UCS1903	10	3
		G	143	11.0					
		B	33.5	2.6					
		RGB	210	16.2					

- The above color temperature values are the finished color temperature.
- The above data are typical values. Due to tolerances in the production process, characteristics of electronic components, and other factors, the test parameters will have an error of $\pm 10\%$.
- The maximum serial connection length is for single-ended power input.
- For RGB/RGBW/RGBW/SPI, the maximum connection length refers to the recommended connection length of single-ended power supply when the LED strip is fully loaded. In practical applications, depending on the effect of the controller driving the LED strip, the serial connection can be extended as appropriate in the case of low power.

Wire

Wire type	Picture	Specification	Core number	Electrical property
		20AWG red, black 2 PIN	● ●	Red V+, Black V-
		20AWG brown, white, yellow 3 PIN	● ○ ●	Tunable white: brown V+, white W, yellow WW
		20AWG brown, white, yellow 3 PIN	● ○ ●	SPI: Brown V+, White DI, Yellow GND
PVC wire		20AWG black, blue, red, green 4 PIN	● ● ● ●	Black V+, Blue B, Red R, Green G
		20AWG black, white, blue, green, red 5 PIN	● ○ ● ● ●	Black V+, White W, Blue B, Green G, Red R
		20AWG black, blue, red, green, yellow, white 6 PIN	● ● ● ● ● ○	Black V+, Blue B, Red R, Green G, Yellow WW, White W

Cut mark

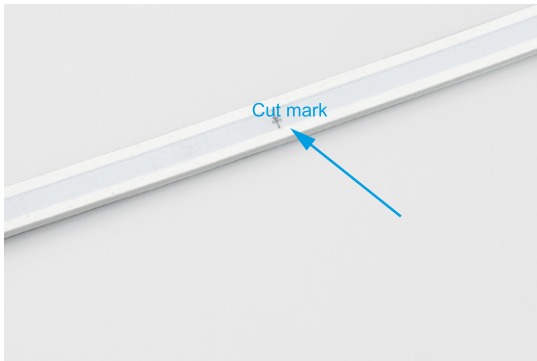

Remarks: There is a transparent window at the bottom of the LED strip, and the black mark is the cutting position;



Make precise vertical cuts at the exact cut position of the LED strip.

Mounting clip

C8 clip

8MM Mounting clip

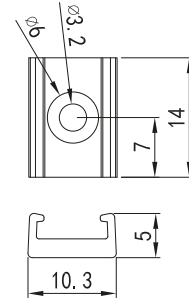

Size :
14x10.3x5
Accessory :
PA 3X 10
Self-tapping screw

C10 clip

10MM Mounting clip

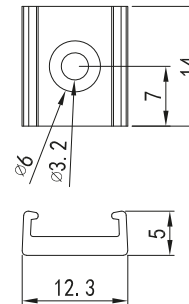

Size :
14x12.3x5
Accessory :
PA 3X 10
Self-tapping screw

C12 clip

12MM Mounting clip

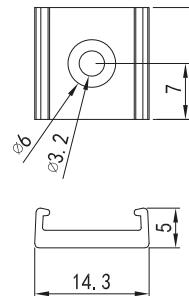

Size :
14x14.3x5
Accessory :
PA 3X 10
Self-tapping screw

C14 clip

14MM Mounting clip

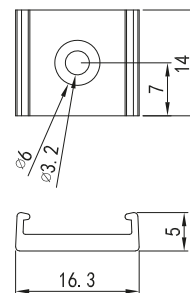

Size :
14x16.3x5
Accessory :
PA 3X 10
Self-tapping screw

Quick Connector (Note: The maximum carrying current is 5A; The waterproof grade is reduced to IP20 after using the quick connector)

10mm Quick Connector

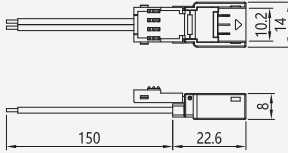

Single color (Red&Black 2-core Cable ,Red V+,Blck V-)
 CCT Tunable (Brown&White&Yellow 3-core Cable ,
 Brown V+, White W, Yellow WW)
 Digital RGB(Red&Green&Black 3-core Cable , Red V+,
 Green DI, Black GND)

12mm Quick Connector

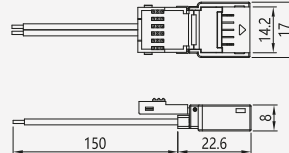

Single color (Red&Black 2-core Cable ,Red V+,Black V-)
 CCT Tunable (Brown&White&Yellow 3-core Cable ,
 Brown V+, White W, Yellow WW)
 Digital RGB(Red&Green&Black 3-core Cable , Red V+,
 Green DI, Black GND)
 R G B(Black&Blue&Red&Green 4-core Cable ,Black V+,
 BlueB, Red R, Green G)

14mm Quick Connector

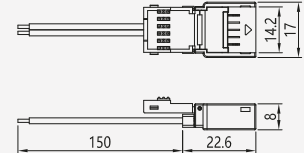

Single color(Red&Black 2-core Cable ,Red V+, Black V-)
 CCT Tunable (Brown&White&Yellow 3-core Cable ,
 Brown V+, White W, Yellow WW)
 Digital RGB(Red&Green&Black 3-core Cable , Red V+,
 Green DI, Black GND)
 R G B(Black&Blue&Red&Green 4-core Cable ,Black V+,
 BlueB, Red R, Green G)
 RGBW(Black&White&Blue&Green&Red 5-core Cable ,
 Black V+, White W, Blue B, Green G, Red R)

Assembly Diagram

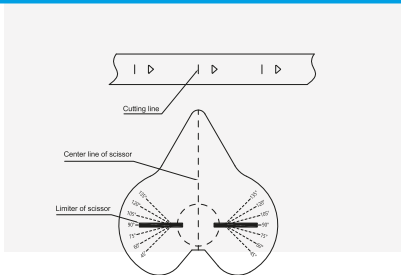

1. Align the scissor with the cutting line on the back of the dotless line.

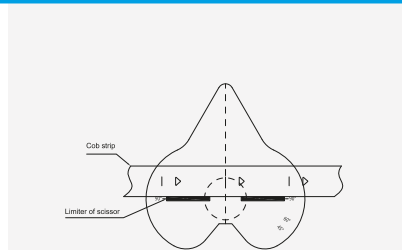

2. Place the dotless line parallel to the scissor and cut the dotless line neatly.

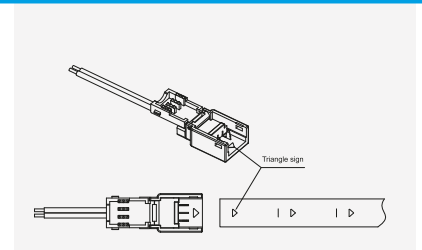

3. Align the triangle sign on the dotless line with that on the quick connector. (Note: The directions of the two triangle signs must be consistent to avoid short circuit.)

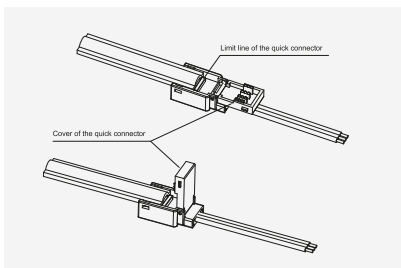

4. Align the dotless line with the limit line on the quick connector, and then press the cover until you hear the click sound.

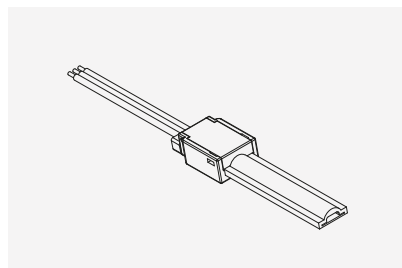

5. Schematic diagram of installation completion.

Disassembly Diagram

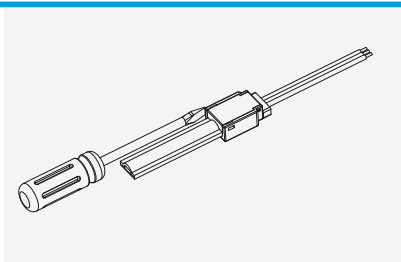

1. Use a flat-head screwdriver to pry the side of the quick connector along the side gap, and then pry another side.

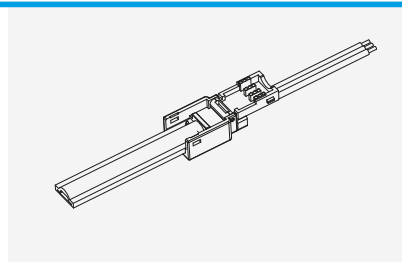

2. Open the cover and remove the dotless line with the needle. Note: When the removed dotless line is used again, the unit length of dotless line that FPCB has been punctured must be cut off to avoid poor contact during reinstallation.

Single color wiring diagram

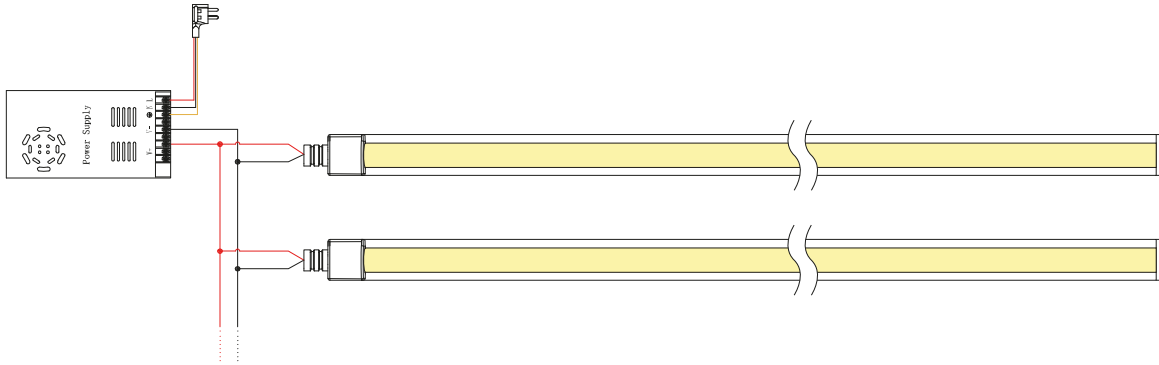

Tunable white wiring diagram

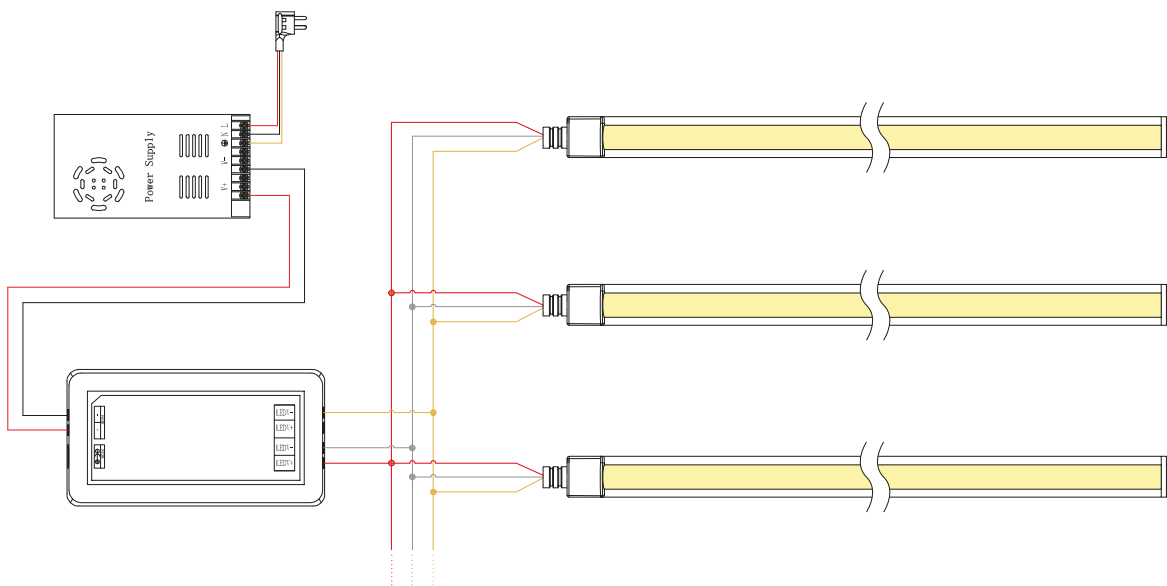

RGB wiring diagram

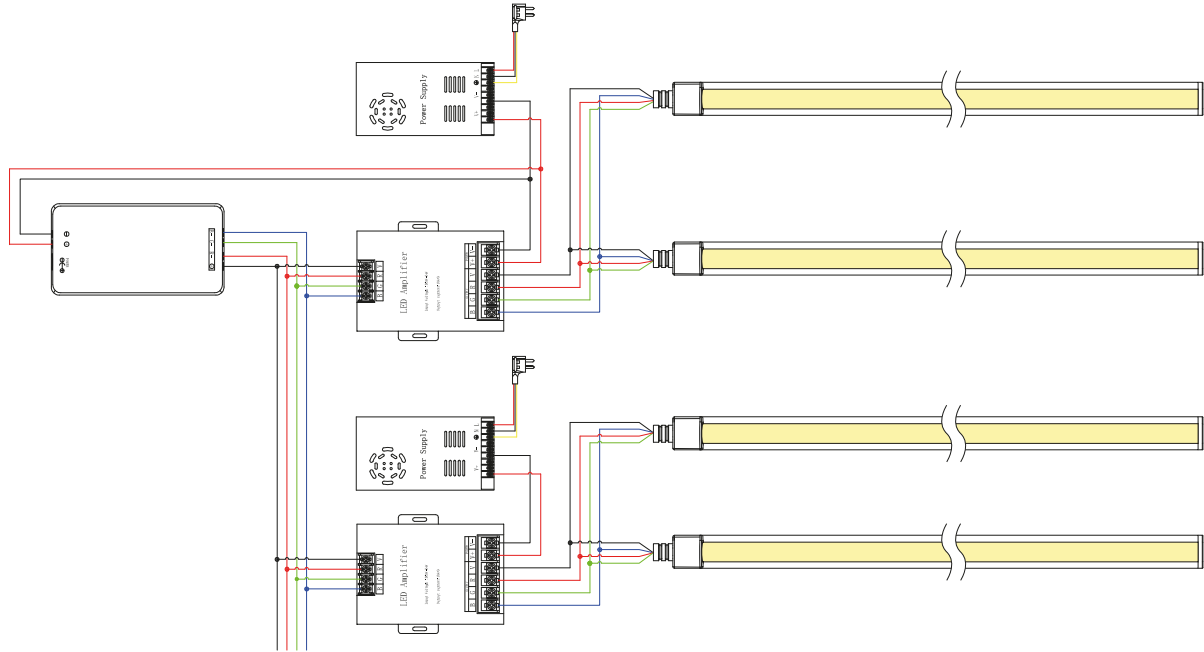

RGBW wiring diagram

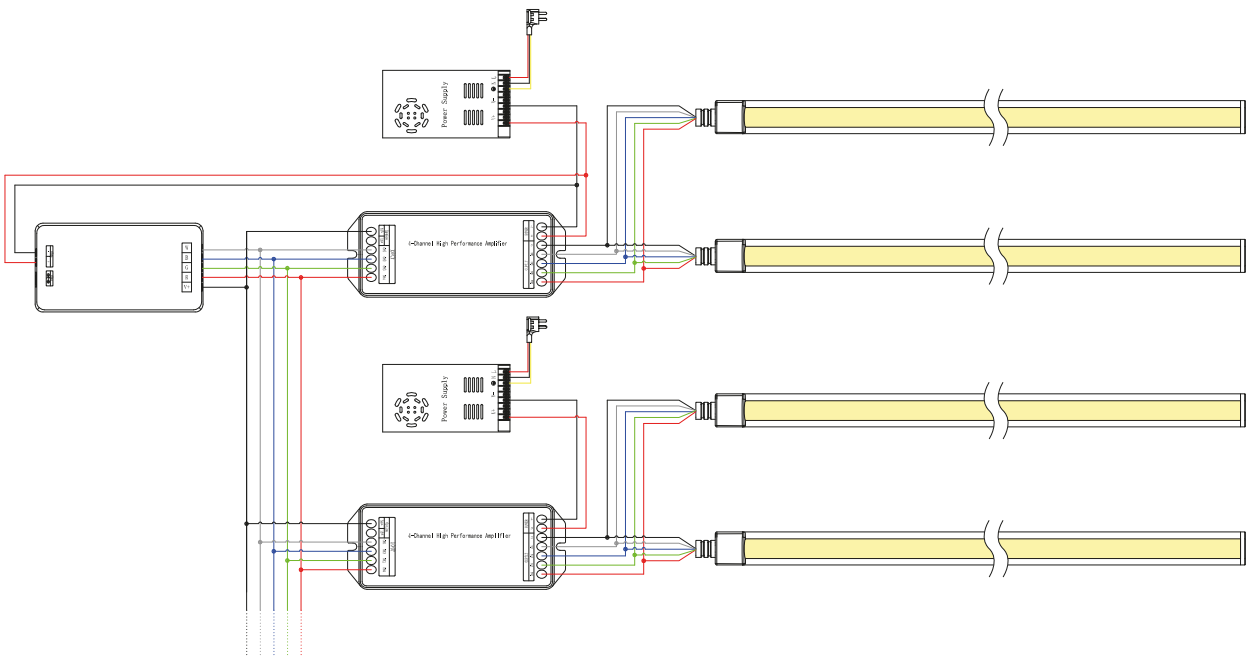

RGBTW wiring diagram

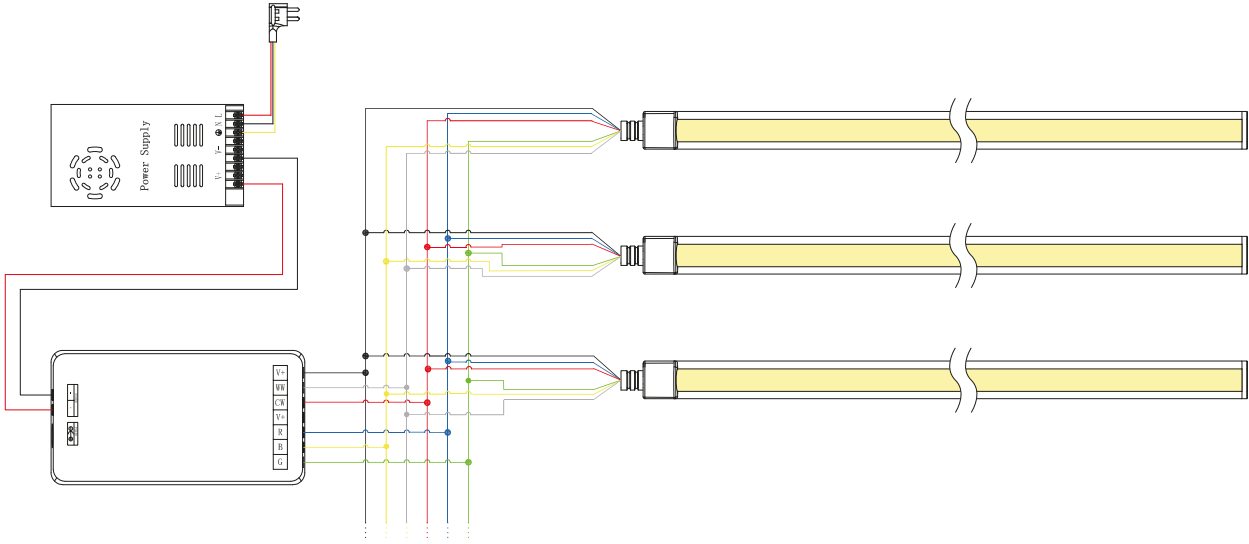

SPI wiring diagram

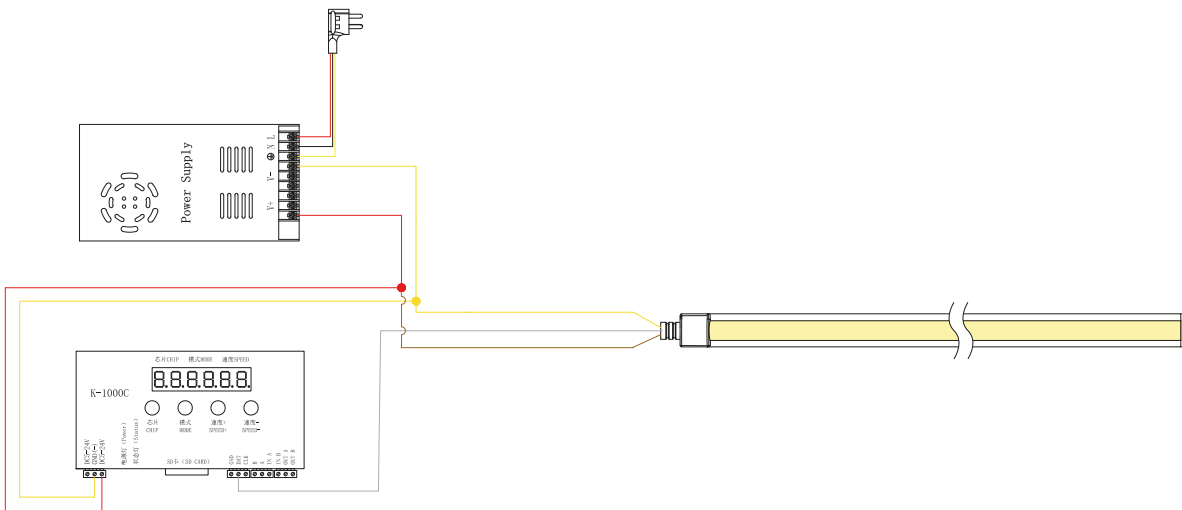

Installation diagram

Installation by 3M adhesive

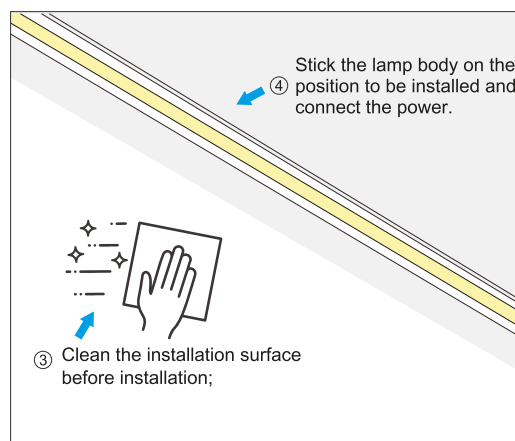
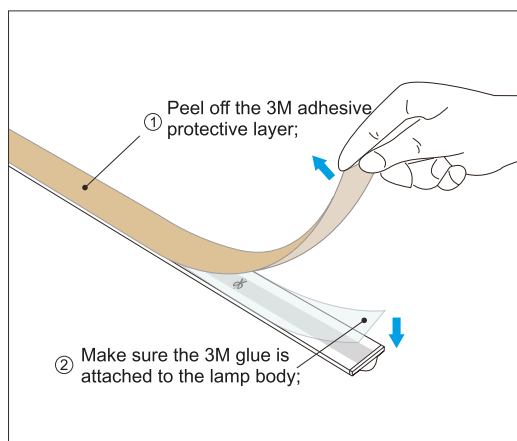

Installation by mounting clip

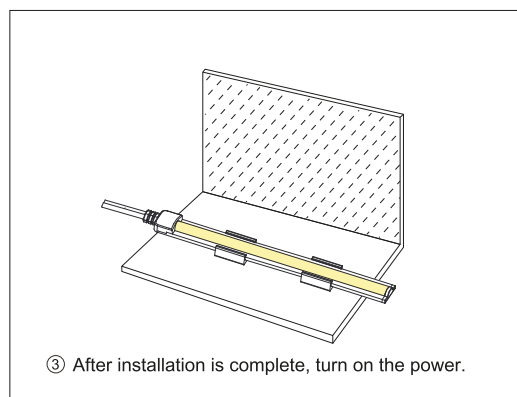
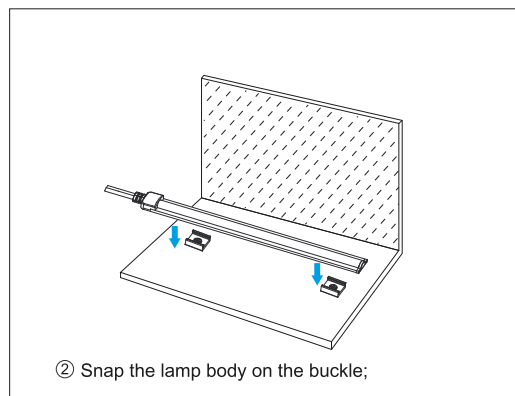
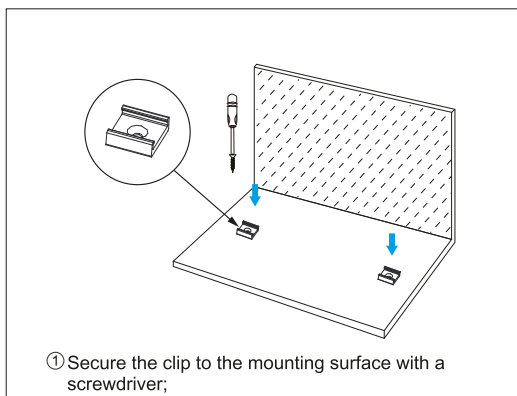

Precautions

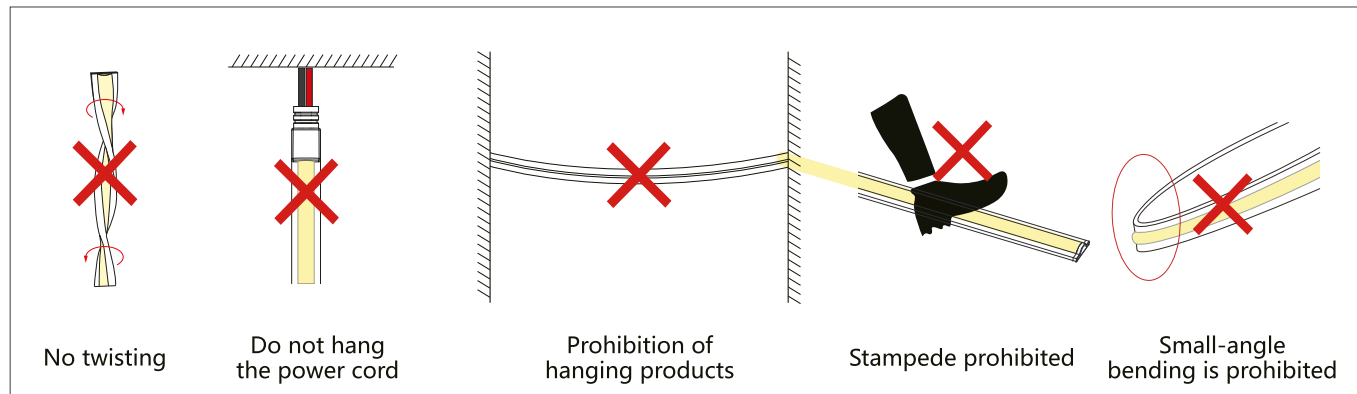

- ※ Unused products and products that have not been used after unpacking should be sealed in packaging bags to avoid prolonged exposure.
- ※ Please use DC24V isolated constant voltage switching power supply with ripple voltage less than 5%. Using other types of power supply may damage the product or cause other safety risks.
- ※ In practical applications, the power supply should reserve 20% of the margin (recommended to use only 80% of the power) to ensure the stability of the power supply.
- ※ It is recommended to connect the power supply wiring by professionals, and it is strictly forbidden to connect the power supply with electricity to prevent electric shock.
- ※ Pay attention to the positive and negative poles of the power cord, and do not connect them incorrectly; whether the voltage of the power supply and the product is the same, so as to avoid damage to the product.
- ※ When using multiple power supplies, avoid the situation where the positive poles of the power supplies are connected in parallel with each other, otherwise the power supply system will be unstable and long-term operation will result in damage.
- ※ If the actual application length exceeds the specified use length, it will cause the lamp strip to be overloaded and heated, and the brightness will be uneven.
- ※ Please avoid scratching, twisting and irregular bending of the product during installation, otherwise it may cause irreparable damage to the product.
- ※ In order to ensure the life and reliability of the light strip, please do not be smaller than the minimum bending diameter specified by the product. Too small bending diameter will damage the product itself.
- ※ In order not to hurt your eyes, try to avoid staring at the light-emitting surface of the light bar that is being lit for a long time.
- ※ Non-professionals are prohibited from installing, disassembling and maintaining the product.
- ※ It is strictly forbidden to use any acid or alkaline adhesive to fix the product (including but not limited to glass glue, etc.).
- ※ Different IP grades of products have different usage scenarios, and IP65 is not suitable for water immersion environments.
- ※ IP68 products are only factory-assembled, and the waterproof level needs to be downgraded when the user processes and cuts them by himself.
- ※ Products of different sizes and specifications have a slight deviation in the final color due to structural differences under the same color temperature value, and must be confirmed before use.

Tests have shown that formazan and benzene substances will have a yellowing effect on silica gel; in the new indoor decoration environment, epoxy floor paint, wall paint, wallpaper adhesive, various decoration materials or new furniture, It is possible to release formazan and benzene substances. It is recommended that in the newly renovated indoor environment, formaldehyde and benzene should be removed or ventilation should be carried out for a period of time before the installation of light bars to avoid yellowing of the silica gel of the lamp body.