

- Ceiling-mounted PIR motion sensor switch, built-in daylight sensor, real-time detection of human motion and ambient light level in the sensing area.
- Output 1 channel 0/1-10V signal, connect with 0/1-10V dimmable driver.
- High voltage AC input, High voltage AC relay output with zero-cross detection.
- Tuya smart APP cloud control, smart linkage to other Tuya devices.
- Set the sensor sensitivity, hold time, stand-by time and light sensing threshold via APP.
- Hold time, stand-by time and light sensor threshold can also be set with the 3 knobs.
- Work as RF remote, output RF 2.4G signal, matched with RF LED controller or RF dimmable LED driver optional.
- Suitable for office, meeting room, classroom and other indoor space light sensor control.



CE RoHS

Technical Parameters

Input voltage	100-240VAC	Hold time	10s/30s/90s/3min/10min/30min/+∞
Output signal	0/1-10V (Max.30mA), RF 2.4GHz	Stand-by time	0s/30s/90s/3min/10min/30min/+∞
Output current	Max 4A (AC)	Daylight threshold	10lux/30lux/50lux/100lux/150lux/200lux/Disable(off)
Power consumption	<1.8W(Operation)	Operation temperature	Ta: -20°C ~ +50°C
Detection zone	Max.(DxH) 10 x 5m	IP rating	IP20
Mounting height	5m Max	Warranty	5 years
Detection angle	120°		

Mechanical Structures and Installations

Back:

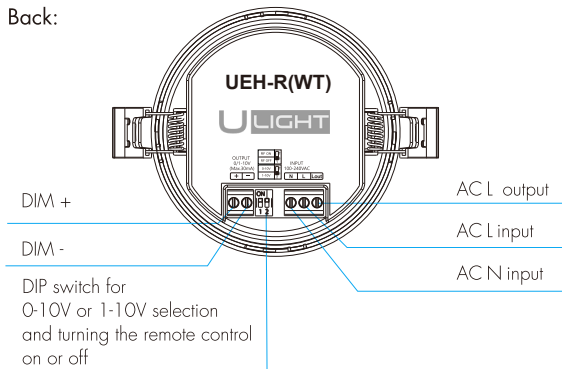

Dimension:

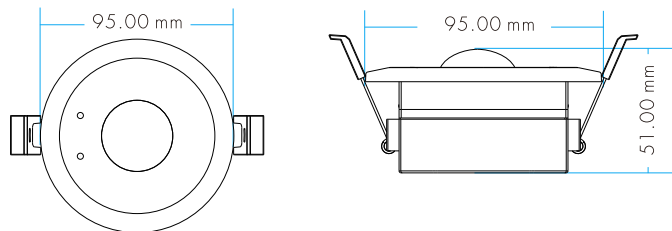

Disassemble:

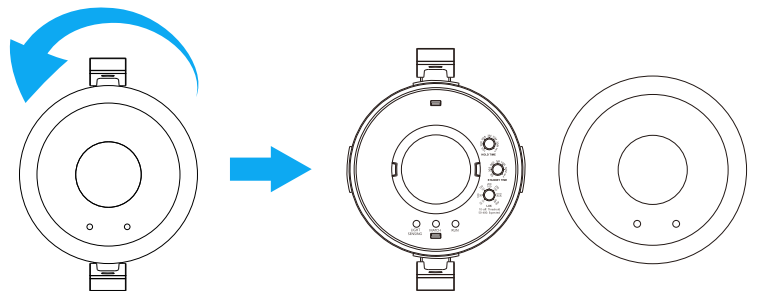

Front:

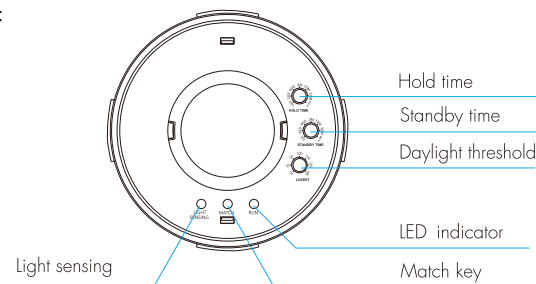

Ceiling Installation:

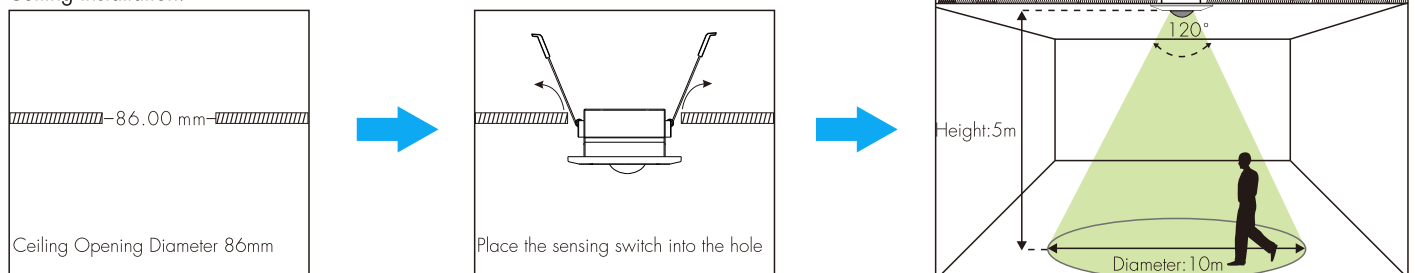

## System Wiring

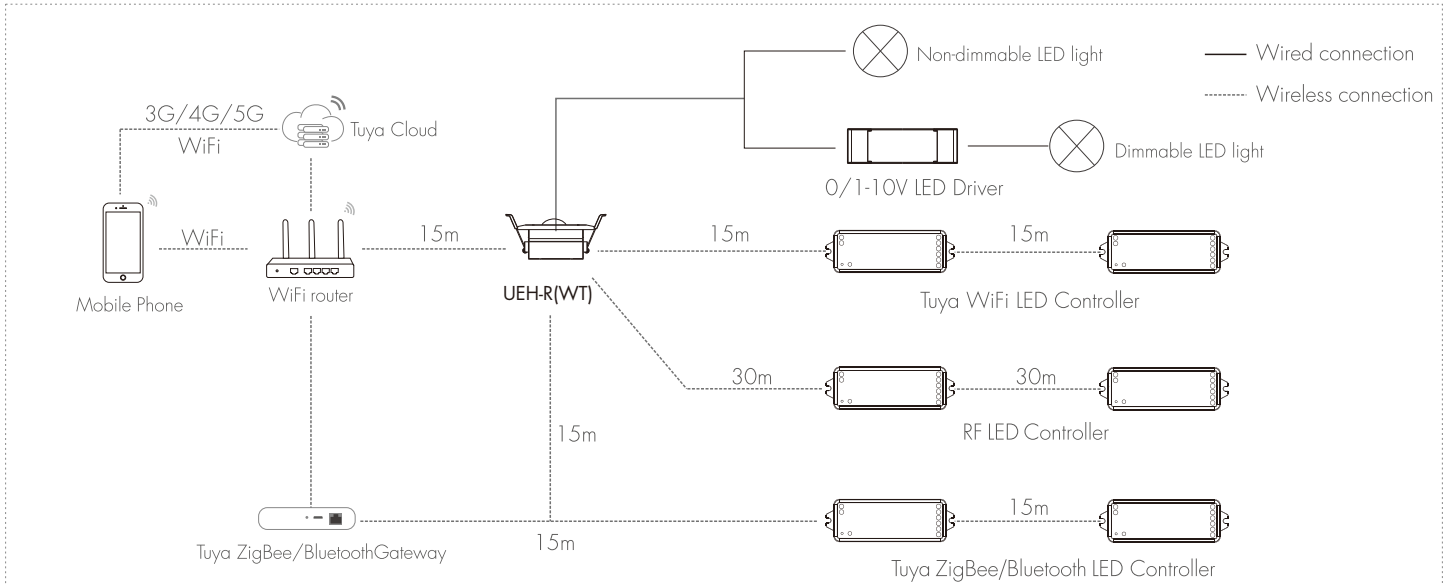

- Note:
1. The above distance is measured in spacious (no obstacle) environment, Please refer to the actual test distance before installation.
  2. Please check if the WiFi router net in 2.4G band, the 5G band is not available, and do not hide your router network.
  3. Please keep the distance between UEH-R(WT) devices and router close, and check the WiFi signals.
  4. WiFi signal strength detection: open the main interface of social security, click enter the device interface, click "check device network" for testing.

## Wiring Diagram

• Used as dimmer or switch, connect with 0/1-10V dimming driver (no use AC OUT).

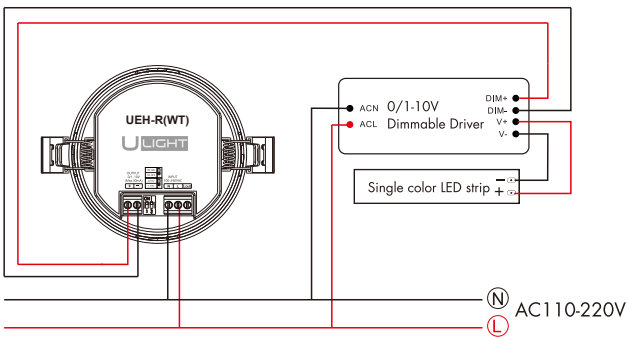

• Used as switch, connect with non-dimmable LED light (use AC OUT).

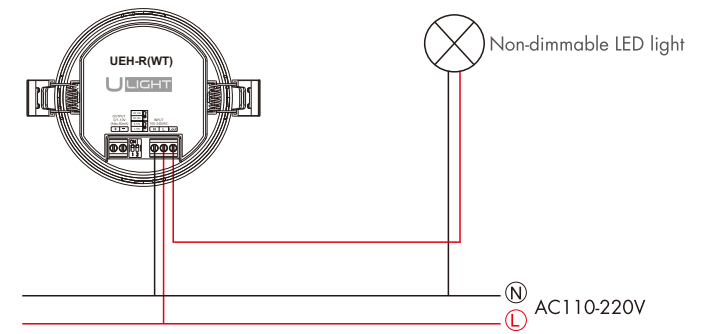

## Application Notice

1. The sensor is designed for indoor use only.  
The raining or wind blowing may trigger the microwave sensor even if without human motion when outdoor use.
2. please turn off the power before installing.
3. Ensure that the lens section is mounted exposed and unobstructed.
4. The distance between any two sensors should be at least 3m to avoid interference each other.
5. If the sensor is exposed to direct sunlight, interference signal will be introduced.
6. Make sure that the sensor stays away from heat source, such as countertops, kitchen appliances which generate hot steam, walls and windows in direct sunlight, air conditioner, heating, refrigerators, stoves and so on.
7. There should not be shelter (screen, furniture, large bonsai) within the range of detection.
8. Make sure there are no fans, DC motor, or other vibrating objects in installation area. The movement will trigger sensor as well.

## Work as RF Remote (two match ways)

UEH-R(WT) can be matched with one or multiple RF LED controller or RF dimmable LED driver, including single color, dual color, RGB, RGBW, RGB+CCT controller or driver, turn on or turn off light by motion detection.  
Before matching, User need to turn on the RF remote control function by DIP switch 1.

End user can choose the suitable match/delete ways. Two options are offered for selection:

### Use the controller's Match key

Match:  
Short press the match key of the controller, immediately press the match key of UEH-R(WT).

Delete:  
Press and hold the match key of the controller for 5s to delete all match,  
The light blinks 5 times means all matched remotes were deleted.

### Use Power Restart

Match:  
Switch off the power of the controller, then switch on power, repeat again.  
Immediately short press the match key of UEH-R(WT) 3 times.  
The light blinks 3 times means match is successful.

Delete:  
Switch off the power of the controller, then switch on power, repeat again.  
Immediately short press the match key of UEH-R(WT) 5 times.  
The light blinks 5 times means all matched remotes were deleted.

The match key of UEH-R(WT) supports manual on/off function, i.e., switching relay output on/off, turning 0/1-10V signal output on/off, and sending RF on/off commands.

## 0-10V or 1-10V Dimming Setting

Select 0-10V dimmer or 1-10V dimmer according to dimmable LED driver(DIP switch 2).

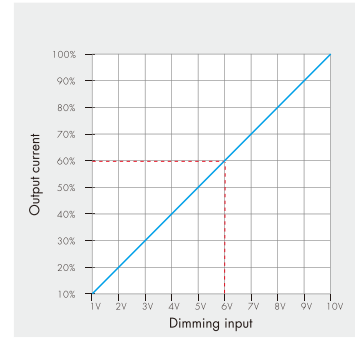
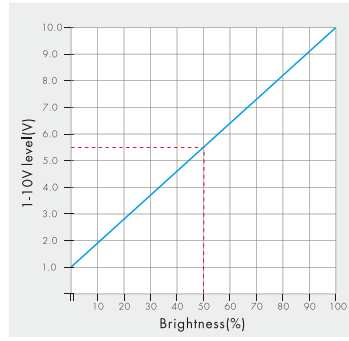
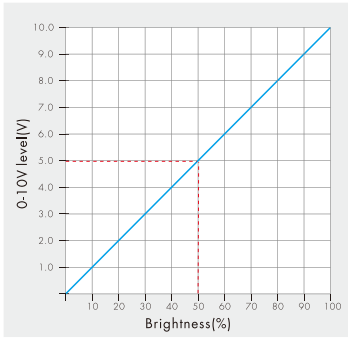

Note:

When the output channel is off, the output dimming signal is 0V or 1V. Please read the dimming section of the dimming driver manual.

If the dimming characteristic curve are as shown, you must select 1-10V dimmer and use AC OUT function, otherwise you can't turn off the lights.

## Knob Function Instruction



**Hold time:**

Refers to the time period remains light on state after no motion detected.



**Stand-by time:**

Refers to the time period remains light on and dim to 20% brightness state if no new motion is detected. Used as a switch, must be 0s.

Used as a dimmer, must be longer than 0s.

If the stand-by time is set to  $+\infty$ , the light stays on (20% brightness).

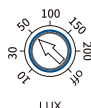

**Daylight sensor:**

The sensor can be set to only allow the lamp to illuminate when below a defined ambient brightness threshold.

When set to off (Disable) mode, the daylight sensor will switch on the lamp when motion is detected regardless of ambient light level.

### Daylight Sensor Threshold Description:

LUX value	Environment	Scene
10LUX	Low light, outdoor shade or indoor low light	Basement, night stairs, underground garage
30LUX	Cloudy or dark environment	Indoor corridors, bedrooms, warehouses
50LUX	Slightly brighter environment	Gym, kitchen, office lounge area
100LUX	Common low to medium illumination	Office workspace, conference room, kitchen
150LUX	Bright environment	Classrooms, shops, hospital corridors
200LUX	Brighter environment	Hotel lobby, public library, operating theatre

**Note:**

Set the hold time, stand-by time, and daylight sensor parameter values while the sensing switch is powered up.

After setting the parameters, when the UEHR(WT) senses a motion, the parameter value works.

When setting the above three parameter values via the knob, it will be automatically synchronised to the Tuya Smart APP.

## Application Example

### Application 1: Used as a dimmer

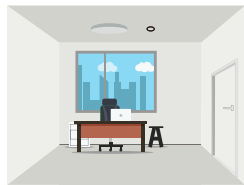

1. With sufficient ambient light, the sensor does not turn on the light.



2. With insufficient ambient light, the sensor turns on the light when human motion is detected.

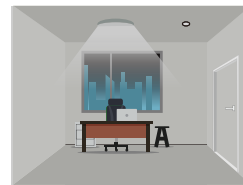

3. After hold time, the light turns to 20% brightness, if no human motion detected.



4. After hold time, the light turns off if no human motion detected.

**Recommended knob setting:**

Hold time: 90S Stand-by time: 3 min Daylight sensor: 50lux



### Application 2: Use as a switch

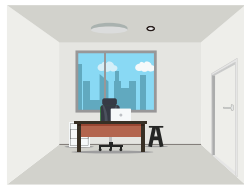

1. With sufficient ambient light, the sensor does not turn on the light.



2. With insufficient ambient light, the sensor turns on the light when human motion is detected.

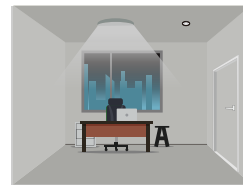

3. After elapse of stand-by time, the sensor turns off the light if no human motion detected.

**Recommended knob setting:**

Hold time: 90S Stand-by time: 0S Daylight sensor: 50lux



## Tuya Smart APP Network Connection

### ● Download and open APP

Search for "Tuya Smart/Smart Life APP" in the app store, or scan the QR code on the right to download the APP. Register and login after installation.



Smart Life



Tuya Smart

### ● APP Pairing Network

Push twice Match key fastly, clear previous network connection, enter WiFi config mode, LED indicator flash fastly. If Tuya Smart APP network connection succeed, the RUN LED indicator will stop flash, and in Tuya Smart APP, you can find UEH-R(WT) device.

When controlling the light with Tuya Smart/Smart Life APP, if the network connection is poor, you can control the light with Bluetooth connection within the Bluetooth control range.

Power failure memory function: When the device is powered on again after power failure, it will remember the hold time, stand-by time, and daylight sensor parameter values last set in Tuya Smart APP.

Note: The light can't be directly controlled by Bluetooth without WiFi configuration.

### ● APP User Interface

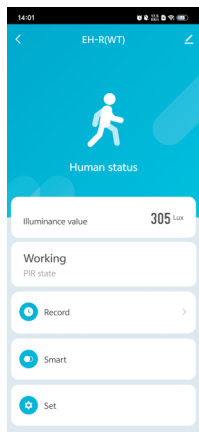

#### Main Interface

**Motion Detection:**  
Real-time detection of motion in the area.  
Real-time detection of ambient light levels.

**Record:**  
The device linkage log can be accessed at any time, the time of movement and number of movements.

**Smart linkage:**  
You can add LED controller or power linkage control that supports Tuya Smart APP.

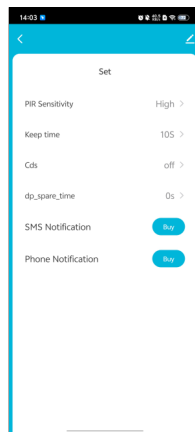

#### Set interface

**PIR sensitivity:**  
3 levels selectable: high sensitivity (for large space detection), medium sensitivity (for indoor general view), low sensitivity (for security scenes).

**Keep time:**  
7 levels selectable (10s,30s,90s,180s,600s,1800s,off).

**Cds:**  
7 levels selectable (10Lux,30Lux,50Lux,100Lux,150Lux,200Lux,off).  
When the ambient light is less than the daylight sensing threshold, turn on the light.

**dp\_space\_time:**  
7 levels selectable(0s,30s,90s,180s,600s,1800s,off).

**Payment service:**  
When someone intrudes into the detection zone, the intrusion warning alert will notify you by SMS or phone call to notify you (purchase required).

## Smart Linkage Setting

Take UEH-R(WT)+ WiFi LED controller as an example, set the mode to turn on the light when someone passes by.

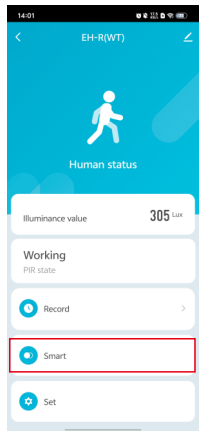

1. Select Smart

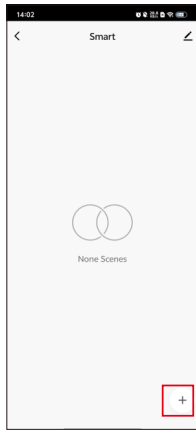

2. Click '+'.  
Enter create scene interface.

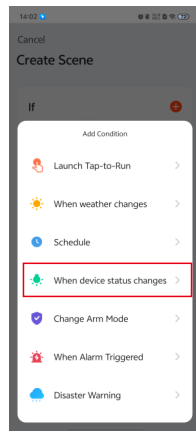

3. Add condition,  
select "When device status changes".

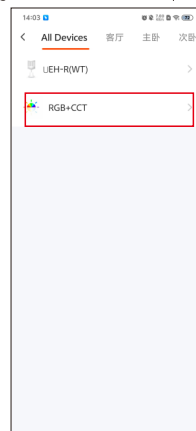

4. Select a device

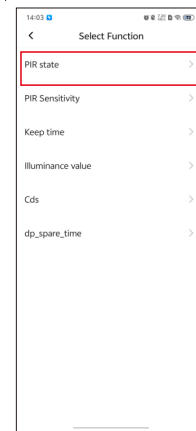

5. Click "PIR state".

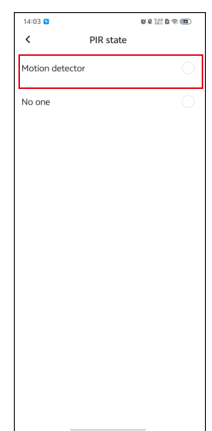

6. Select  
"motion detector".

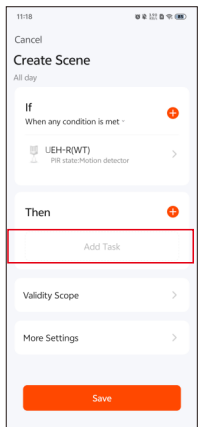

7. Add task.

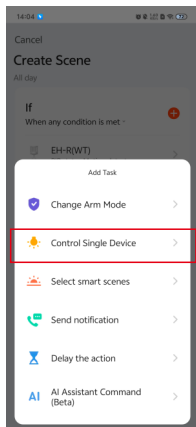

8. Select to control  
single device.

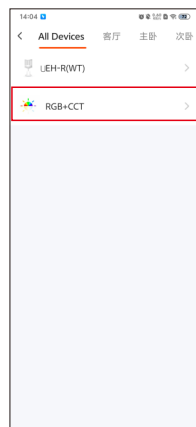

9. Select the device  
you want to linkage  
control.

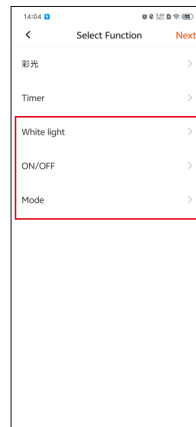

10. Select the function:  
White light(set the brightness),  
switch(on).  
mode(white light).

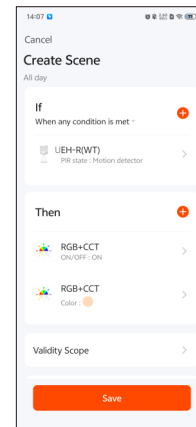

11. Complete the settings  
and click save.