

# Free bending Flexible silicone Wall washer light

Ustrip LED-FW-W40-24V-2621mm





### Product features

- Using optical grade environmental protection silicone material, salt resistance, acid and alkali corrosion resistance, flame retardant, UV resistance;
- The free bending structure design can perfectly fit the outdoor curved surface of various arcs to achieve the effect of wall washing
- Integrated extrusion molding process, waterproof grade up to Ip65;
- Patented optical structure design, a variety of angles optional;
- Hidden end cap design, easy to install;



### Product Dimension

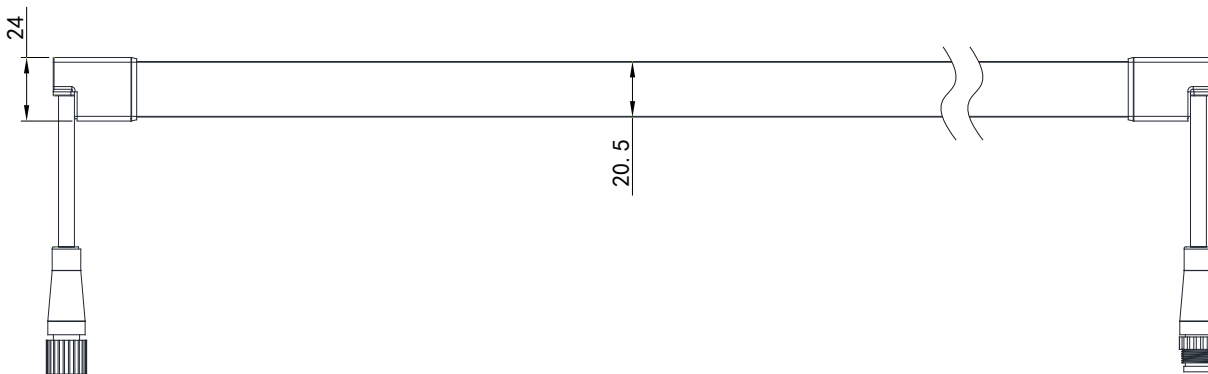
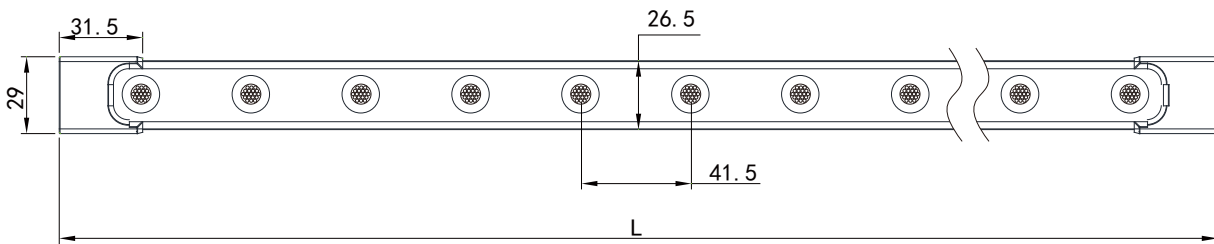

### Basic Parameters

Input Voltage	24V
CRI	>80
Beam angle( 50% )	15°/30°/50°/20*35°/18*20°/20*55°
LEDs / M	24LEDs
Working hours	30000h
Control mode	PWM

Working temperature	-25 ~+40
Cutable length	41.5mm
Waterproof level	IP65
Max.run length	5m
Net weight	590g/m

CCT	Power(W/M)	Lumens/m
6500K <sup>+300K</sup> <sub>-500K</sub>	24W ± 1	1840LM
4000K±200K	24W ± 1	1950LM
3000K±200K	24W ± 1	1815LM
2700K±150K	24W ± 1	1780LM
R(620-630nm)	24W ± 1	270LM
G(520-530nm)	24W ± 1	1175LM
B(440-460nm)	24W ± 1	165LM

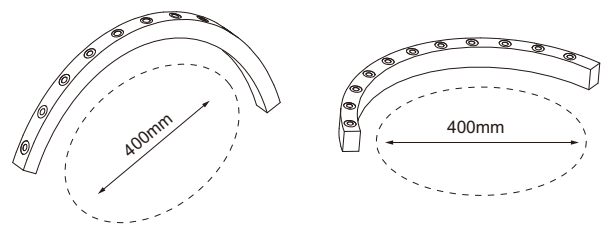

Bending Diameter

Remarks: 1. Test ambient temperature: 25 (±2 ) ; 2. Brightness deviation: ±10%;

### Light Distribution Curve

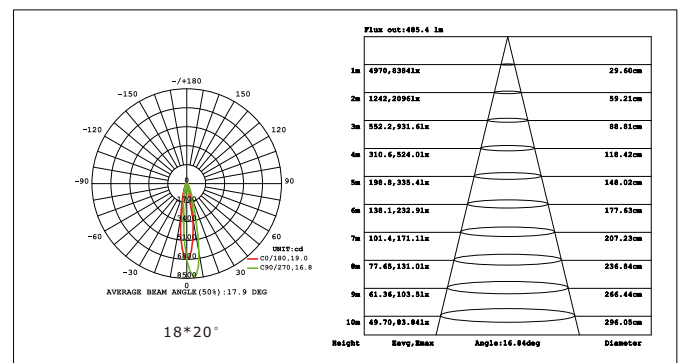
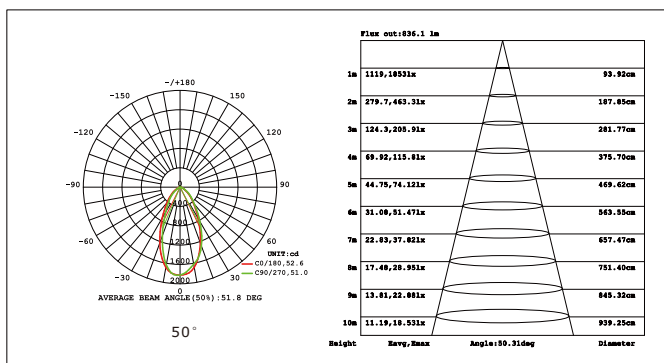
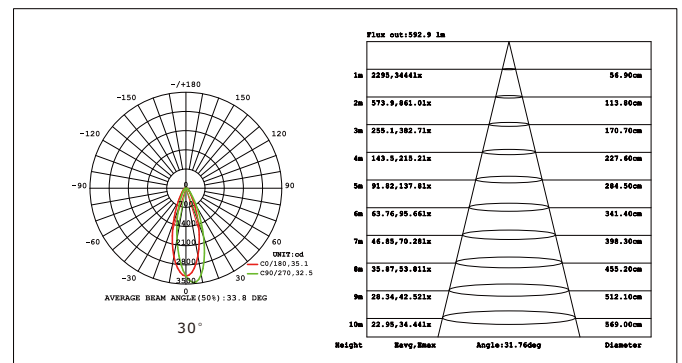
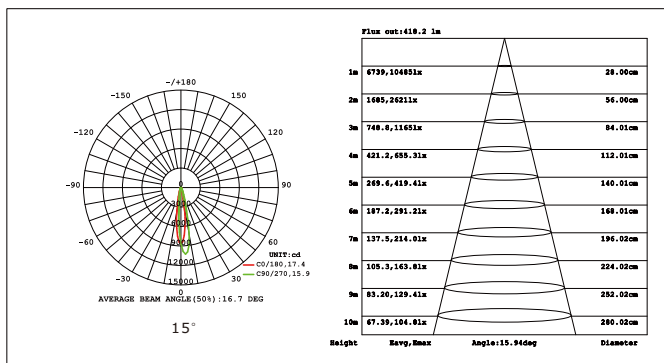

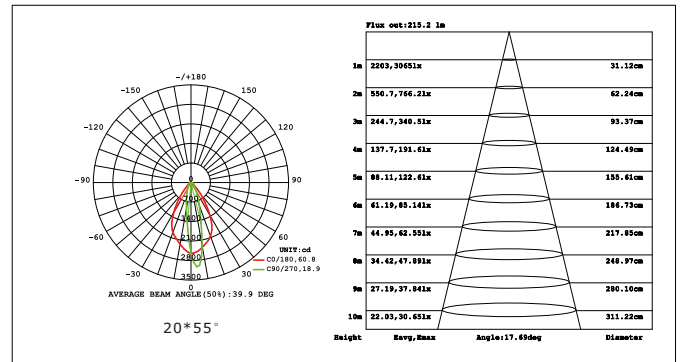
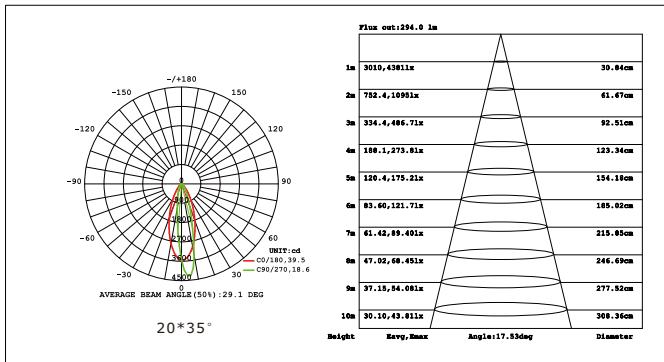

Accessories



Aluminum Clip

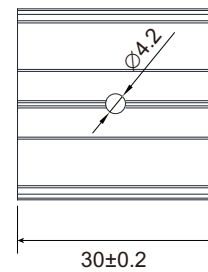
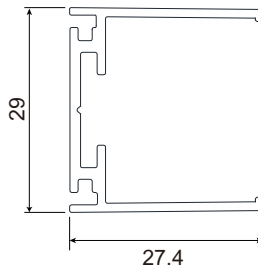

Adjustable Angle Clip

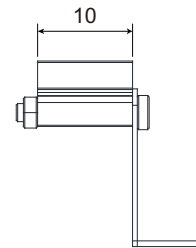
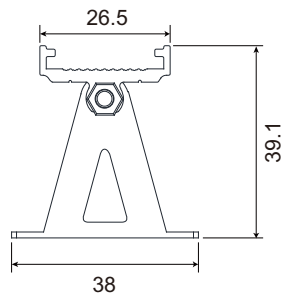

Aluminum Profile

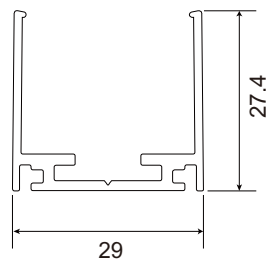

## Installation Diagram

Installation with  
Aluminum Clip

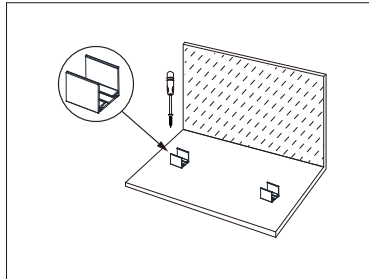

Fix the aluminum clips to the mounting surface with the screwdriver.

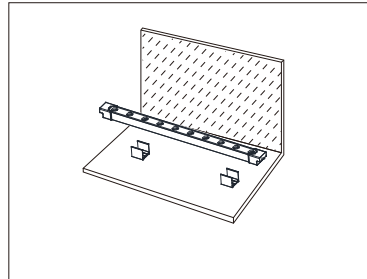

Clamp the wall washer light on the aluminum clips;

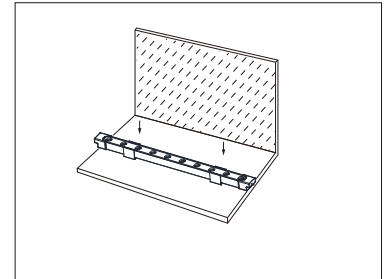

Turn on the power.

Installation with  
Aluminum Profile

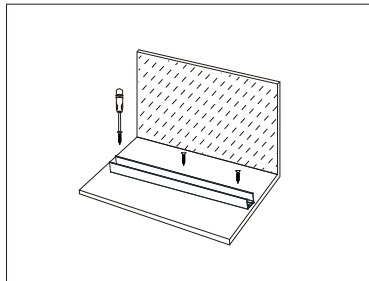

Fix the aluminum profile to the mounting surface with the screwdriver.

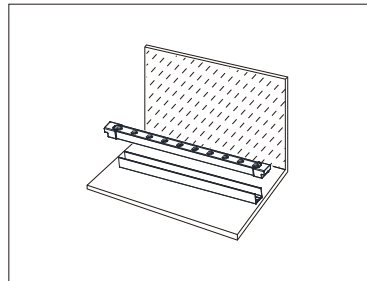

Clamp the wall washer light on the aluminum profile;

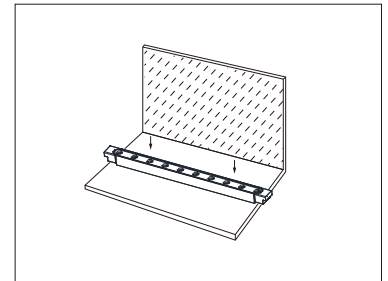

Turn on the power.

Installation with  
Adjustable Angle Clip  
+  
Aluminum Clip

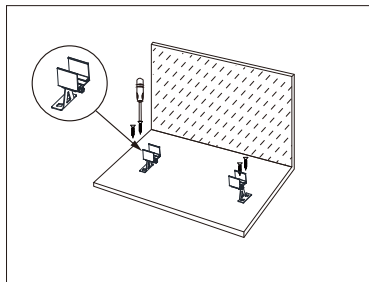

Fix the adjustable angle clips to the mounting surface with the screwdriver, then fix the aluminum clips onto the adjustable angle clips.

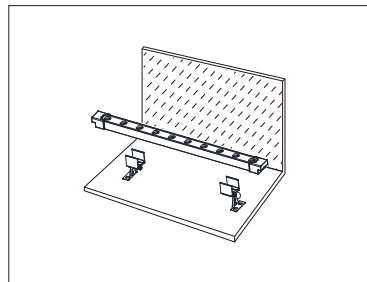

Clamp the wall washer light on the aluminum clips.

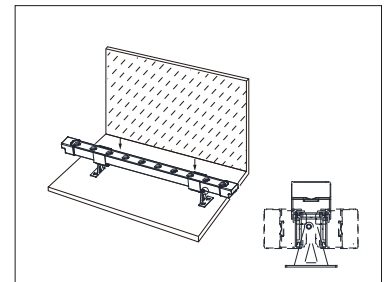

As shown in the schematic diagram in the right corner, adjust the clips to the required angle, and then turn on the power.

Installation with  
Adjustable Angle Clip  
+  
Aluminum Profile

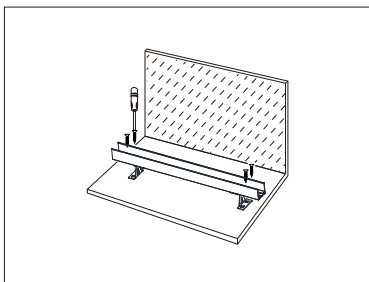

Fix the adjustable angle clips to the mounting surface with the screwdriver, then fix the aluminum profile onto the adjustable angle clips.

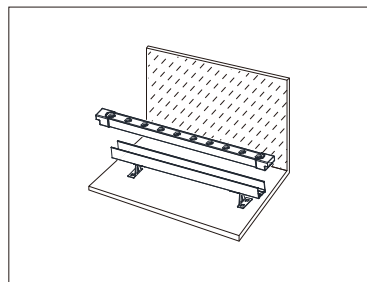

Clamp the wall washer light on the aluminum profile.

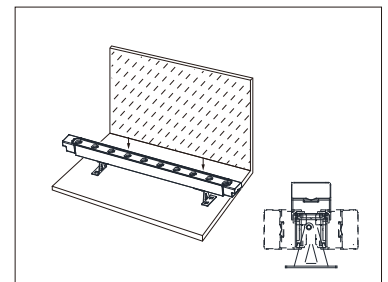

As shown in the schematic diagram in the right corner, adjust the aluminum profile to the required angle, and then turn on the power.

## Wiring diagram

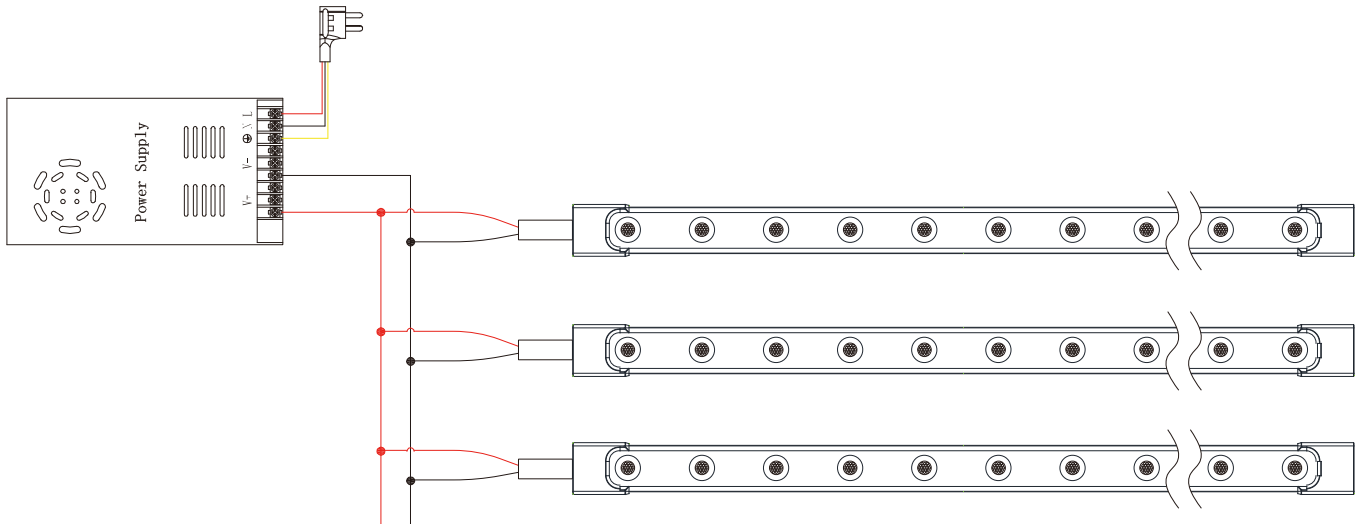

## Description of Product Model Code

Model: IP65 LED-FW2621-W40-24V a000056

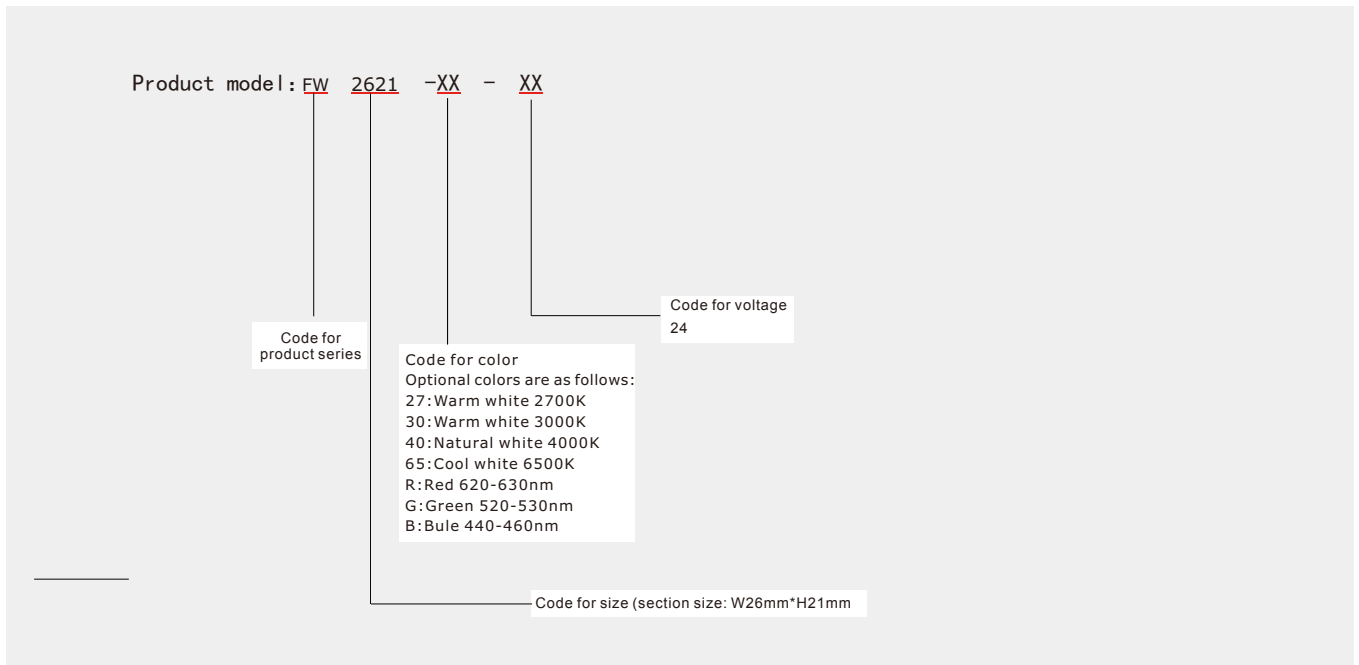

For example: The code of FW26212424652055 means the section size of the wall washer light is 26x21mm, and the voltage is DC24V, the power is 24W/M, the color temperature is 6500K, the beam angle is 25x55° .