

- WiFi & RF DALI master, 5 in 1 function, support single color, color temperature, RGB, RGBW, RGB+CCT light control.
- Tuya APP cloud control, support on/off, color temperature and brightness adjustment, delay on/off light, scene function and dynamic mode.
- Adopts TFT 1.54-inch LCD color screen display, 240x240 resolution, 9 touch buttons, easy and intuitive setup and operation.
- Compatible with 5 light types, support DT6 dimming, DT8-TC color temperature, DT8-RGB, DT8-RGBW, DT8-RGB+CCT.
- In accordance with DALI standard protocol IEC 62386-101, 102, 207, 208, 209 and in compliance with DALI products from other international incorporation.
- Enable to select DALI address, support unicast, group and broadcast mode.
- Precise adjustment of color, color temperature and brightness via the display and the left and right buttons.
- 4 scene buttons for quick recall scenes.
- Optional RF 2.4G remote control available.
- Tempered glass touch panel, available in white or black.



CE RoHS emc RED

Technical Parameters

Input and Output		Dimming data		Safety and EMC	
Power	100-240VAC	Input signal	RF 2.4GHz + Touch Key	EMC standard (EMC)	ETSI EN 301 489-1 V2.2.3 ETSI EN 301 489-17 V3.2.4
Static current	≤2mA	Control distance	30m(Barrier-free space)	Safety standard	EN 61348-1:2015+A1:2021 EN 61348-2-13:2014+A1:2017
Output signal	DALI	Dimming gray scale	255 levels	Radio Equipment(RED)	ETSI EN 300 328 V2.2.2
Environment		Package		Certification	CE,EMC,RED
Operation temperature	Ta: -20°C ~ +50°C	Size	L112x W112x H50mm	Protection	
Case temperature (Max.)	Tc: +65°C	Gross weight	0.230kg	Warranty	5 years
IP rating	IP20				

Mechanical Structures and Installations

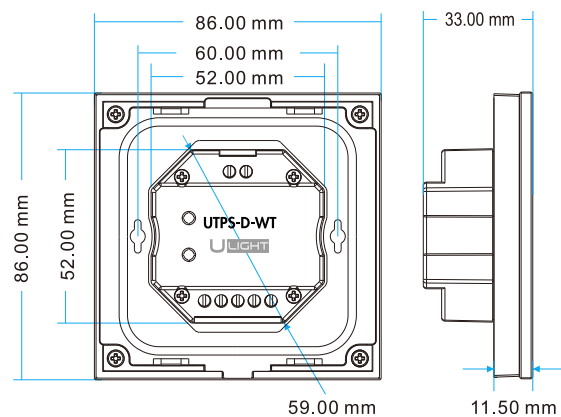
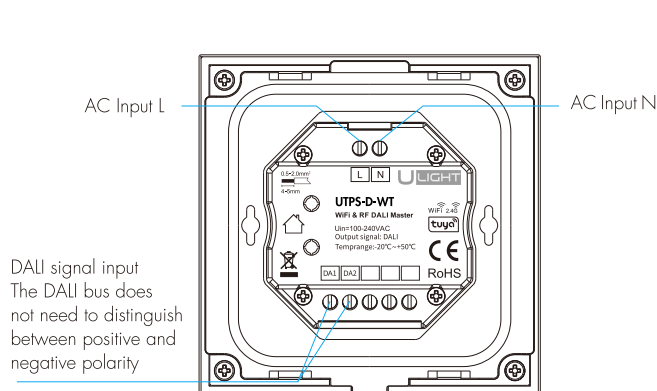

Installation diagram:

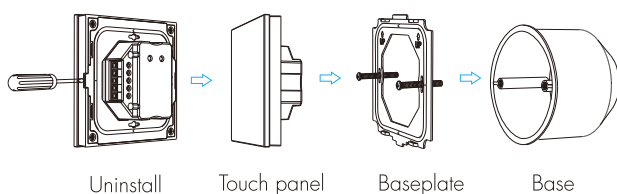

Typical base as below:

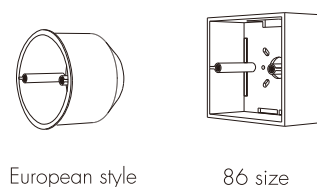

System wiring

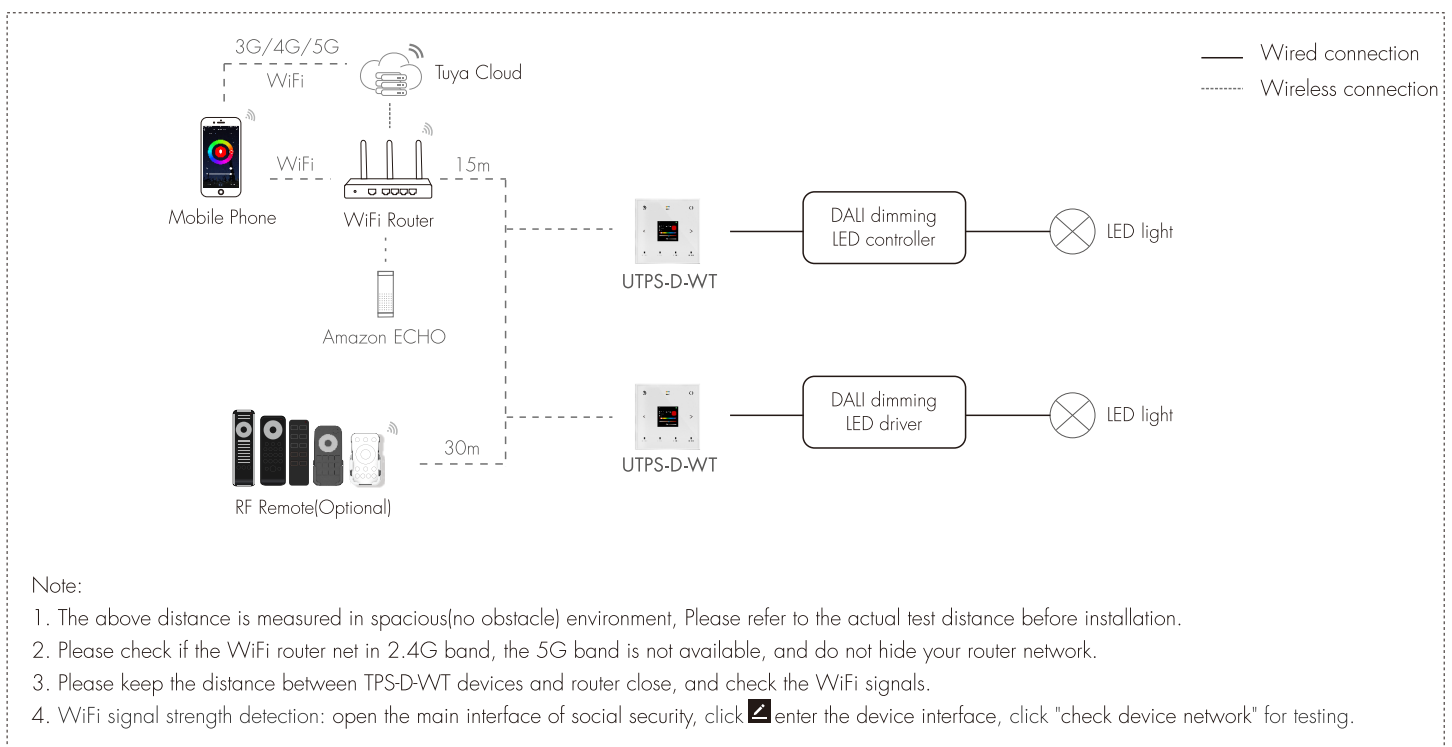

Functions & Main Interface

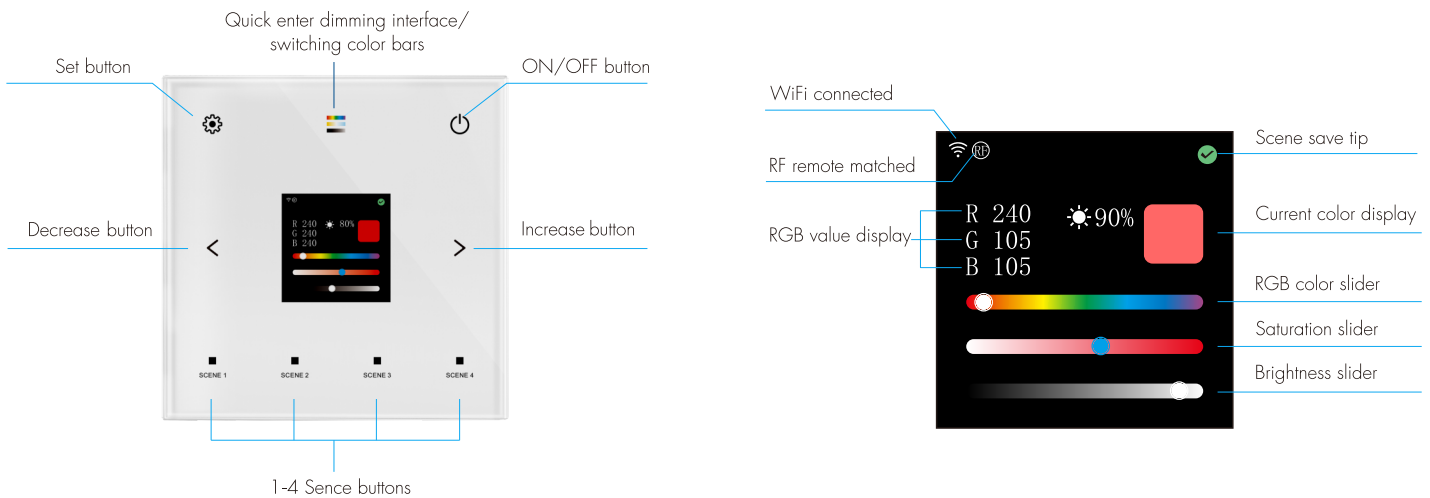

- Short press to turn on/off the light.
Press and hold for 2 seconds to activate delayed light off.
- Short press to enter the screen saver interface, long press 2 seconds to enter or exit the system setting interface;
Under the system setting interface, short press to switch each setting item sequentially, and long press to return to the previous interface.
- Short press to enter dimming interface;
Under the dimming interface, short press to switch the color, saturation, color temperature or brightness sliders.
- Under the system setting interface, short press to change the value of each setting item;
Under the dimming interface, short press to the left to quickly adjust the color, saturation, color temperature or brightness, and long press to slow down the continuous adjustment.
- Under the system setting interface, short press to change the value of each setting item;
Under the dimming interface, short press to the right to quickly adjust the color, saturation, color temperature or brightness, and long press to slow down the continuous adjustment.
- Short press to bring up the scene;
If the scene lock function is off, press and hold for 5 seconds to save the current light status to scene 1/2/3/4, the upper right corner of the screen indicates that the scene was saved successfully.



- Long press button to enter the system set interface.
- Short press button to select each set item sequentially, and long press button for 2s or wait 15s to quit system setting state.
- **General Set:** include time set, display set, setup lock set, scene lock set, and restore factory set.
- **Light Type:** short press < or > button to switch 5 light types (DIM, CCT, RGB, RGBW, RGB+CCT).
- **Delay OFF:** short press < or > button to switch 10 kinds of delayed light off time (10s, 30s, 1min, 3min, 5min, 10min, 30min, 1hour, 2hour, 4hour).
- **Language:** short press < or > button to switch between Chinese or English.
- For WiFi Config, RF Match, DALI Set and scene Set, press > button to enter the corresponding sub-set interface.

1. WiFi Config



- Download the Tuya smart APP for your area.
- After entering the system set interface, select WiFi Config, short press > button to WiFi Config sub-interface, enter WiFi Smart configuration mode, "Config..." is displayed at the bottom of the screen.
- In the Tuya smart APP, you can find DIM devices (or other CCT, RGB, RGBW or RGB+CCT devices). After successful connection, "Config OK!" is displayed at the bottom of the screen, automatically exits the WiFi Config sub-interface in 40 seconds, and the WiFi icon is displayed in the upper left corner of the main interface.

2. RF Match



- After entering the system set interface, select RF Match, press > button to enter the RF Match sub-interface.
- **RF Match:** Short press button to select RF Match, short press > button to enter the RF remote matching state, "Matching ..." is displayed at the bottom of the screen. After 5s, it will exit the matching state automatically. Immediately short press the ON/OFF key of the single zone RF remote or the zone key of the multi-zone RF remote, and "Matching OK!" will be displayed at the bottom of the screen. After successful matching, the RF remote control icon will be displayed in the upper left corner of the main interface. 1 DALI master can receive up to 10 RF remotes.
- **Delete Match:** Short press > button to select Delete Match, short press > button to delete RF match, and "Delete OK!" will be displayed at the bottom of the screen.

3. DALI Set



- After entering the system set interface, select DALI Set, short press > button to enter the DALI Set sub-interface.
- Short press button to switch each DALI set item, long press button for 2s to return to the system set interface.
- **AddrType:** short press < or > to switch between Unicast, Group and Broadcast modes.
- **Dev Addr:** short press < or > to set the Unicast address (00-63) and Group address (00-15). In broadcast mode, the device address displays "-".
- **Addr Set:** short press > to assign this short address or group address to all DALI controllers or dimming drivers on the bus, "Setting..." is displayed at the bottom of the screen.
- **FadeTime:** short press < or > to set the fade time / cancel the fade time (0.7s, 1s, 1.4s, 2s, 2.8s, 4s, 5.7s, 8s, 11.3s, 16s, 22.6s, 32s, 45.3s, 64s, 90.5s).
- **Max CT:** short press < or > button to set the max color temperature range (5000K~8000K), short press to add/subtract 50K each time; long press to quickly add/subtract 1K.
- **Min CT:** short press < or > button to set the min color temperature range (1000K~4000K), short press to add/subtract 50K each time; long press to quickly add/subtract 1K.
- DALI address, fade time, maximum or minimum color temperature setting operation are broadcast way, that is, full control. Special DALI controller or dimming driver that does not need to be operated, please disconnect the power directly.

4. Scene Name

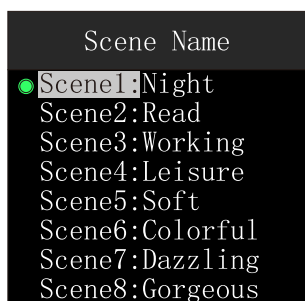

- After entering the system set interface, select Scene Name, short press > button to enter the Scene Name sub-interface.
- Short press button to switch the name set of each scene 1-8, long press button for 2s to return to the system set interface.
- Short press < or > button to set the scene name, 20 kinds of scene names are available: Night, Read, Working, Leisure, Soft, Colorful, Dazzling, Gorgeous, Go home, Leave, Comfort, Bright, Play, Film, Reception, Party, Dinner, Romantic, Rest, Sleep.

5. General Set

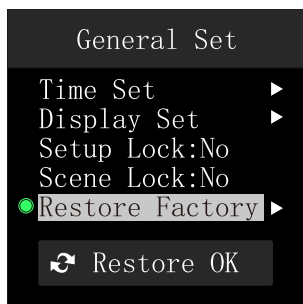

- After entering the system set interface, select General Set, short press > button to enter the General Set sub-interface.
- Short press ⚙️ button to switch each general set items sequentially, long press ⚙️ button for 2s to return to system set interface.
- **Setup Lock:** short press < or > button to select whether or not to allow long press ⚙️ button for 2s to enter system set interface. When the system parameters have been set, it is recommended that ⚙️ button be locked to ensure that the user can not perform setup operations. When ⚙️ button is locked, you can press the ⚙️ button 5 times to enter the system set interface.
- **Scene Lock:** short press < or > to set whether the panel's scene button memory function is locked or not. When set to unlocked, you can long press scene 1-4 buttons for 5s to memorize the current light status as scene 1-4. When set to lock, scene 1-4 buttons have no long press memory function.
- **Restore Factory:** short press > button to restore factory set, the screen will display "Restore OK".
- For Time Set, Display Set, short press > button to enter the corresponding sub-set interface.

5.1 Time Set

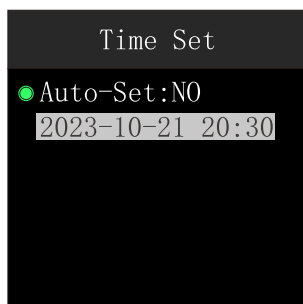

- After entering the General Set sub-interface, select Time Set, short press > button to enter the Time Set sub-interface.
- **Auto-Set:** short press < or > button to select whether to enable auto set or not. When the auto set is on, you can connect the Tuya APP to get the time automatically. The current time is displayed immediately when the auto set is turned off. Short press ⚙️ button to switch the year-month-day-hour-minute setting in sequence. Short press < or > button to set the date and time. Long press ⚙️ button for 2s to exit the Time Set sub-screen.

5.2 Display Set

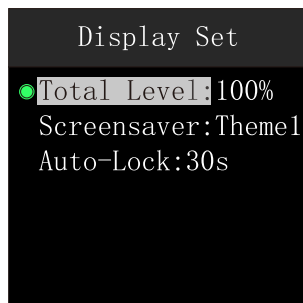

- After entering the General Set sub-interface, select Display Set, short press > button to enter the Display Set sub-interface.
- Short press ⚙️ button to select each display set item sequentially, long press ⚙️ button for 2s to exit display set sub-interface.
- **Total Level:** short press < or > button to set screen brightness 10-100%.
- **Screensaver:** short press < or > button to switch between four screen saver style interfaces.
- **Auto-Lock:** short press < or > button to set the screen saver interface lock time (none, 30s, 1 min, 5min).

Dimming Interface

DIM

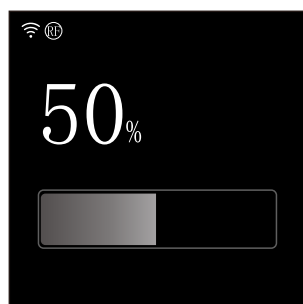

CCT

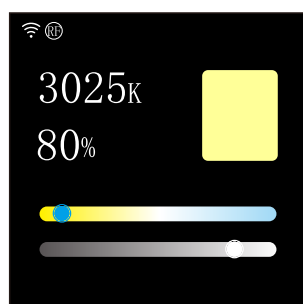

RGB

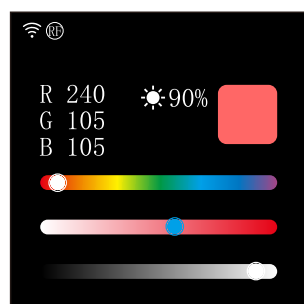

RGBW

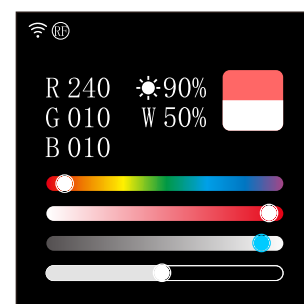

RGB+CCT

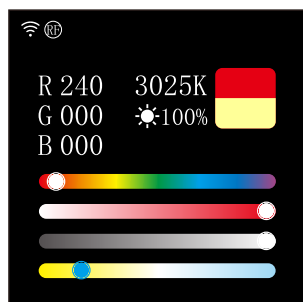



🌈 : Switch multiple colour sliders sequentially.

< : Short press to the left for fast adjustment of seven colors (12 levels), saturation (11 levels), brightness (10 levels), color temperature (11 levels), long press for slow continuous adjustment.

> : Short press to the right to quickly adjust the seven colors (12 levels), saturation (11 levels), brightness (10 levels), color temperature (11 levels), long press for slow continuous adjustment.

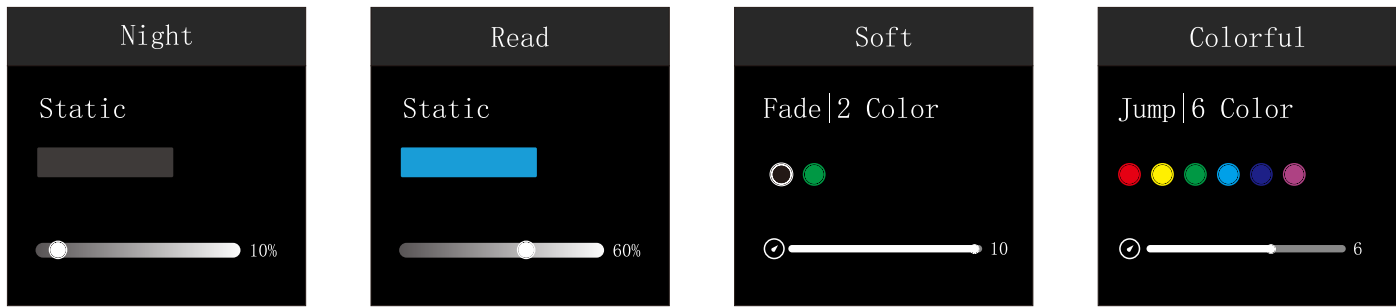
Scene Interface



- Short press scene 1-4 button to call up the corresponding scene.
- Scene Memory: after setting the light effect on the dimming interfaces, if the scene button lock function is off, long press the scene 1-4 button for 5s to save the current light effect into the corresponding scene, and the successful saving will be indicated at the upper-right corner of the screen.
- The dimming interfaces supports saving static scenes only.
- Dynamic scene edit, need to connect to Tuya APP or match RF remote control operation.
- In scene mode, short press the  button to close the current scene and the top right of the screen prompts "".

Dynamic Mode

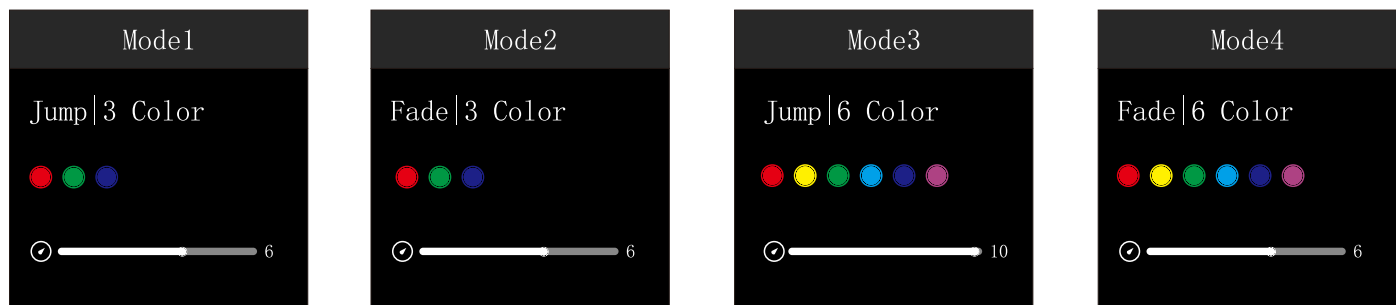

- Dynamic mode only supports RF remote control.
- When matched the RF remote control, you can switch between 10 dynamic change modes and adjust the speed by the remote control.
- In dynamic mode, short press the  button to turn off the current dynamic effect, and the top right of the screen prompts "".

Delayed OFF/ON

Delayed OFF

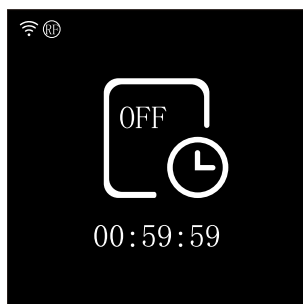

Delayed ON

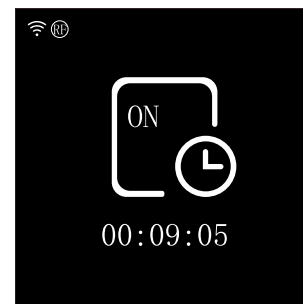

- Long press the  button for 2s to realize the delayed light off, the delayed light off time can be changed through the system set interface.
- The panel button only supports delayed light off (10 seconds - 4 hours).
- Tuya APP can be set to delay the light off or delay the light on (1 minute - 24 hours).

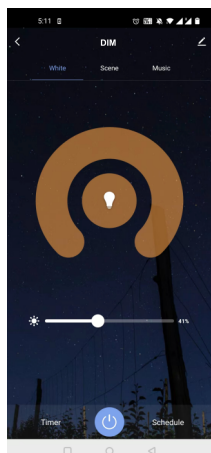

White interface

For DIM type:
Touch brightness slide to adjust brightness.

For RGB type:
Touch brightness slide, get RGB mixed white firstly, then to adjust white brightness.

For RGBW type:
Touch brightness slide, adjust white channel brightness.

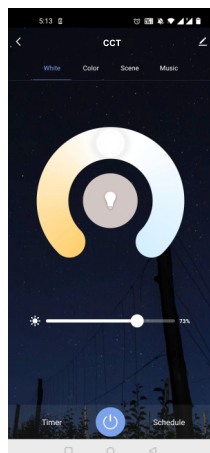

Color temperature interface

For CCT type:
Touch color wheel to adjust color temperature.
Touch brightness slide to adjust brightness.

For RGB+CCT type:
Touch color wheel to adjust color temperature, RGB will turn off automatically.
Touch brightness slide to adjust white brightness.

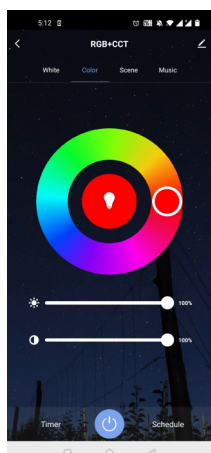

Colour interface

For RGB or RGBW type:
Touch color wheel to adjust static RGB color.
Touch brightness slide to adjust color brightness.
Touch saturation slide to adjust color saturation, namely gradient from the current color to white(RGB mixed).

For RGB+CCT type:
Touch color wheel to adjust static RGB color, CCT will turn off automatically.
Touch brightness slide to adjust color brightness.
Touch saturation slide to adjust color saturation, namely gradient from the current color to white (RGB mixed)

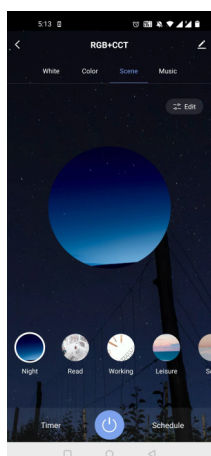

Scene interface

The 1-4 scene is static color for all light type. the inner color of these scene can be editable.
The 5-8 scene is dynamic mode for RGB type, such as green fade in and fade out, RGB jump, 6 color jump, 6 color smooth.

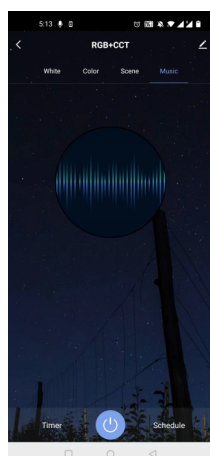

Music, Timer, Schedule

The music play can use smart phone music player or micro-phone as music signal input.
The Timer key can turn on or turn off light in the next 24 hours.
The Schedule key can add multiple timers to turn on or turn off light according to different time periods.