

Mechanical Structures and Installations

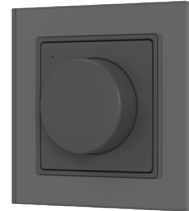
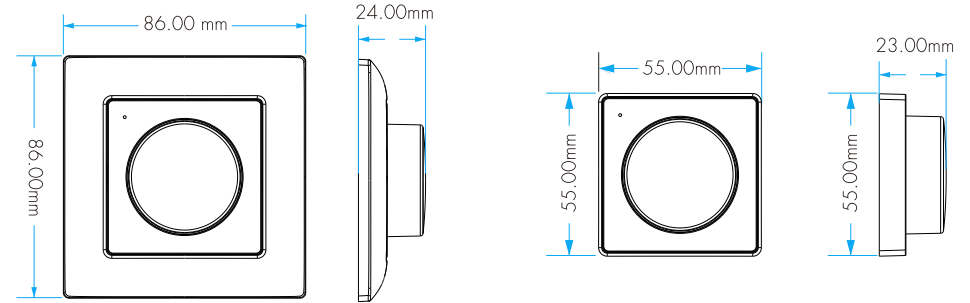

UPB1(C)
Plastic frame (rounded corners)

UPB1(F)
Plastic frame (square corners)

UPB1(G)
Tempered glass frame

CE RoHS

Features

- Apply to single color, dual color or RGB/RGBW/RGB+CCT LED controller.
- Each remote can match one or more receiver.
- The knob adjusts brightness, color temperature, and RGB colors.
- Operate with LED indicator light.
- CR2032 battery powered.
- Removeable and stick anywhere easily, or mount on wall use panel base.
- Three types of panel frame are available.
- White & Black available.

Technical Parameters

Input and Output		Environment		Safety and EMC	
Output signal	RF 2.4GHz	Operation temperature	Ta: -10°C ~ +55°C	EMC standard	EN IEC 55015/ EN IEC 61547-1/-2 ETSI EN 301 489-1/-17
Working voltage	3VDC (CR2032)	IP rating	IP20	Safety standard	EN 61347-1/-2
Working current	< 10mA	Package		Radio equipment	ETSI EN 300 440 ETSI EN 300 328
Standby current	< 10µA			Size	L100 x W88 x H30mm
Remote distance	30m(Barrier-free space)	Gross weight	0.175kg		
Warranty					
Warranty	5 years				

Replace battery:

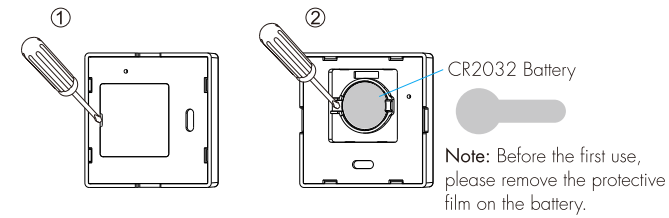

Typical base as below:

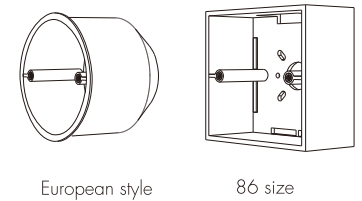

Installation diagram (2 methods):

1. Fix the remote' back holder on the wall with two screws.

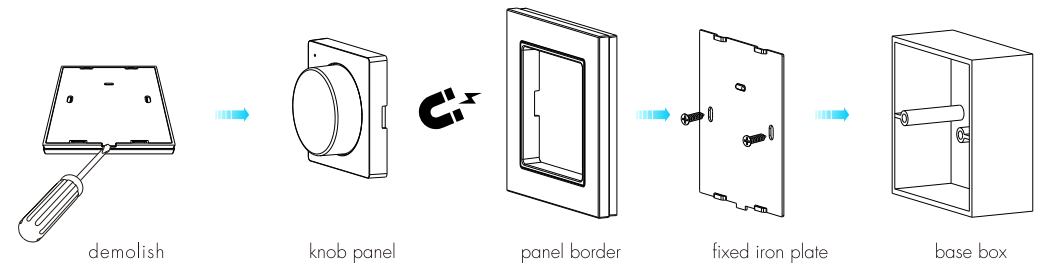

2. Secure the remote control back holder to the wall with 3M adhesive.

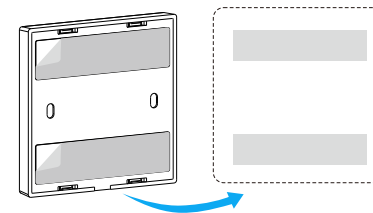

Light Type Setting

Short press set button to switch 5 light types in sequence.

1. When set to DIM light type, the LED indicator light flash 1 time.
2. When set to CCT light type, the LED indicator light flash 2 times.
3. When set to RGB light type, the LED indicator light flash 3 times.
4. When set to RGBW light type, the LED indicator light flash 4 times.
5. When set to RGB+CCT light type, the LED indicator light flash 5 times.

Long press the set button for 2 seconds to restore the default DIM lighting type.

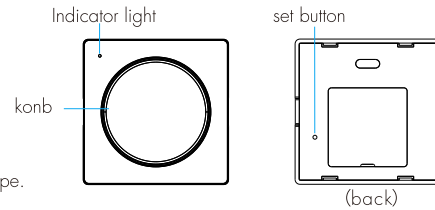

Knob Function

Brightness adjustment



• DIM light type:

Short press: Turn on/off the light.
Rotation: Adjust brightness (2.5 turns, 51 levels).

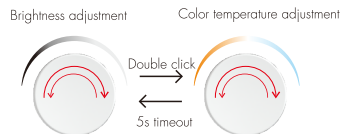

• CCT light type:

Short press: Turn on/off the light.
Double click: Sequentially switch the 3 levels of color temperature (Warm White - Neutral white - Cool White), at the same time enter knob adjust color temperature state.
 After 5 seconds of no operation, it automatically returns to knob adjust brightness state.
Rotation: When knob adjust color temperature, adjust color temperature (1 turn, 21 levels).
 Default knob adjusts brightness (2.5 turns, 51 levels).

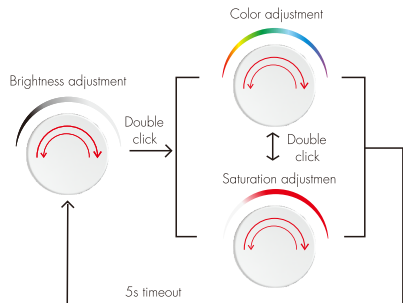

• RGB light type:

Short press: Turn on/off the light.
Double click: Switch between color light and mixed white light (mixed white light defaults to current color + 50% saturation).
 At the same time enter knob adjust color or color saturation state.
 After 5 seconds of no operation, it automatically returns to knob adjust brightness state.
Rotation: When knob adjust color, adjust RGB colors (3 turns, 60 colors);
 When knob adjust color saturation, adjust color saturation (1 turn, 21 levels).
 Default knob adjusts brightness (2.5 turns, 51 levels).

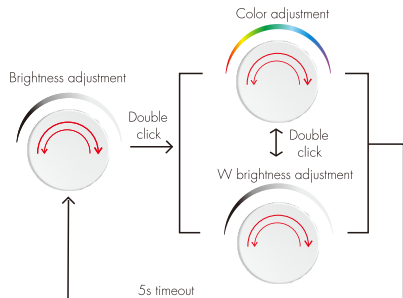

• RGBW light type:

Short press: Turn on/off the light.
Double click: Switch between color light and white light, at the same time enter knob adjust color or white light brightness state.
 After 5 seconds of no operation, it automatically returns to knob adjust brightness state.
Rotate: When knob adjust color, adjust RGB colors;
 When knob adjust white light brightness, adjust the white light brightness (1 turn, 20 levels).
 Default knob adjusts brightness (2.5 turns, 51 levels).

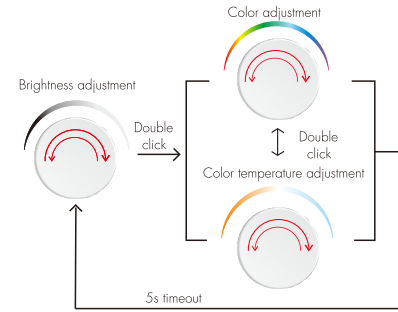

• RGB+CCT light type:

Short press: Turn on/off the light.
Double click: Switch between color light and color temperature light, at the same time enter knob adjust color or color temperature state.
 After 5 seconds of no operation, it automatically returns to knob adjust brightness state.
Rotation: When knob adjust color, adjust RGB colors (3 turns, 60 colors);
 When knob adjust color temperature, adjust color temperature (1 turn, 21 levels).
 Default knob adjusts brightness (2.5 turns, 51 levels).

Match Remote Control

User can choose the suitable match/delete ways. Two options are offered for selection:

Use the controller's Match key

Match:
 Short press the controller's match key, immediately short press the knob.
 The LED indicator fast flash a few times means match is successful.

Delete:
 Press and hold the controller's match button for 5 s.
 The LED indicator fast flash a few times means all matched remotes were deleted.

Use Power Restart

Match:
 Switch off the power of the controller, then switch on power, repeat again.
 Immediately short press the knob 3 times quickly.
 The light blinks 3 times means match is successful.

Delete:
 Switch off the power of the controller, then switch on power, repeat again.
 Immediately short press the knob 5 times quickly.
 The light blinks 5 times means all matched remotes were deleted.

Safety Information

1. Read all instructions carefully before you begin this installation.
2. When installing battery, pay attention to the battery positive and negative polarity.
 A long time without the remote control, remove the battery.
 When remote distance becomes smaller and insensitive, replace the battery.
3. If no response from the receiver, please re-match the remote.
4. Gently handle remote, beware of falling.
5. For indoor and dry location use only.
6. When installing on walls, avoid installing in areas with strong electrical currents.
7. Do not place the device near high-density materials (such as metal or concrete walls) or obstruct it, as this may cause signal attenuation and reduce the remote control range.
8. Remove and immediately recycle or dispose of used batteries according to local regulations and keep away from children.
 Do NOT dispose of batteries in household trash or incinerate.
9. Even used batteries may cause severe injury or death.
10. Call a local poison control center for treatment information.
11. Compatible battery type is CR2032 and the nominal battery voltage is 3V.
12. Non-rechargeable batteries are not to be recharged.
13. Do not force discharge, recharge, disassemble, heat above 55°C or incinerate.
 Doing so may result in injury due to venting, leakage or explosion resulting in chemical burns.
14. Ensure the batteries are installed correctly according to polarity (+ and -).
15. Do not mix old and new batteries, different brands or types of batteries, such as alkaline, carbon-zinc, or rechargeable batteries.
16. Remove and immediately recycle or dispose of batteries from equipment not used for an extended period of time according to local regulations.
17. Always completely secure the battery compartment. If the battery compartment does not close securely, stop using the product, remove the batteries, and keep them away from children.