

MR11 2W30-12V xxx

MR11 2W120-12V xxx

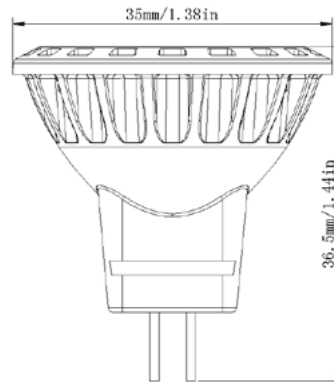

Drawing



Line-Up

Model	Watts(W)	Light Output(lm)	Dimension(mm)	Light Color(K)	Beam Angle(Degree)
MR11 2W30-12V White	2±10%	200±10%	Φ35*36.5	6000	30
MR11 2W30-12V Warm White		170±10%	Φ35*36.5	3000	30
MR11 2W120-12V White	2±10%	160±10%	Φ35*36.5	6000	120
MR11 2W120-12V Warm White		130±10%	Φ35*36.5	3000	120

Technical Specifications

Item	Test Conditions	Min	Typ	Max
Input Voltage(V, rms)	AC		12	
Input Current(mA, rms)	AC(12V)		167	
Input Voltage(V, rms)	DC	10	12	30
Input Power(W, rms) I	DC(All)		2	
Input Frequency(Hz)	DC		20KHz	
Power Factor(PF)	DC(All)			
Output Voltage(V)	DC	9	9.45	9.9
Output Current(mA)	DC	190	200	210
Output Power(W)	DC	1.71	1.89	2.079

Environmental Requirements

Specifications	Values
Operational Temperature Range	-20~40°C
Preservation Temperature Range	-20~90°C
Operational Humidity Range	95%Rh or below (@-20~40°C)
Installation Area	Indoor (Counter,Residential,Commercial,etc)

Material

ADC12
PMMA/PC

IP20
IP20

Watts	2	W
Lumens per Watt(Efficacy)	80	Lm/W
Light Output	160	lm
Light Color(CCT)	6000	K
Beam Angle	120	°(degree)
Color Accuracy(CRI)	70	Ra
Product Weight	16	G
Rating Life	35000	H
Base	GU4	
Input Voltage(DC/AC)	12	V

Model

MR11 2W30-12V White

Luminance Intensity Distribution

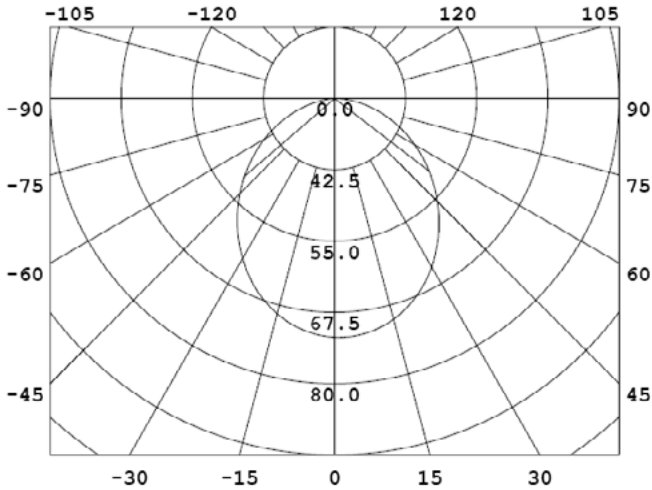

Cone Lux Diagram

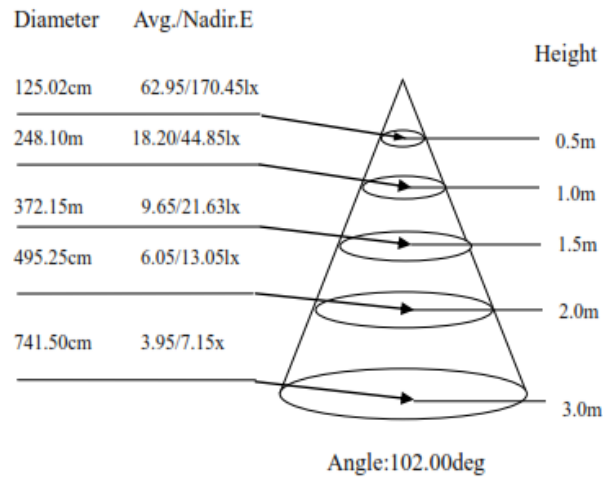

Watts	2	W
Lumens per Watt(Efficacy)	85	Lm/W
Light Output	170	lm
Light Color(CCT)	3000	K
Beam Angle	30	°(degree)
Color Accuracy(CRI)	80	Ra
Product Weight	16	G
Rating Life	35000	H
Base	GU4	
Input Voltage(DC/AC)	12	V

Model

MR11 2W30-12V Warm White

Luminance Intensity Distribution

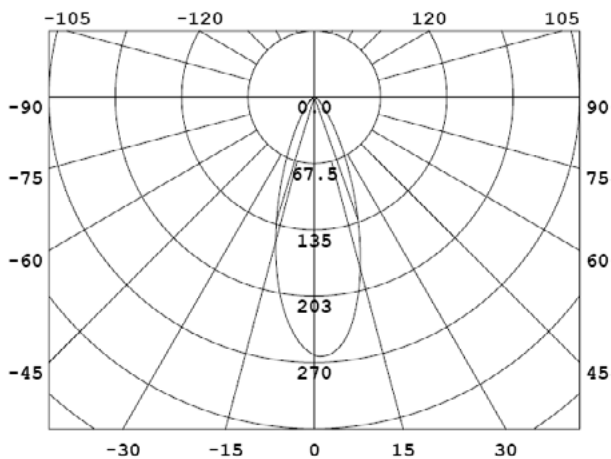

Cone Lux Diagram

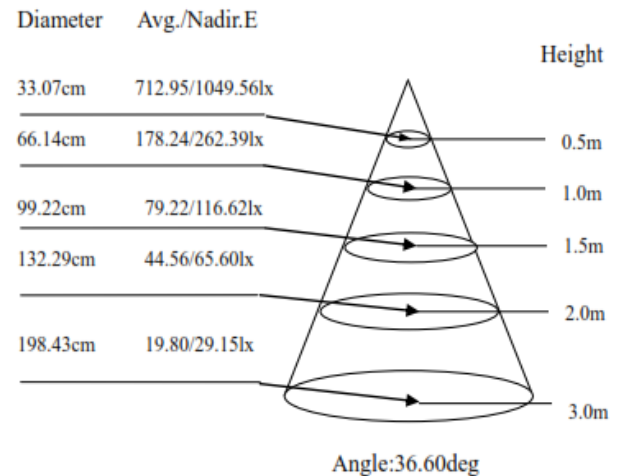

Watts	2	W
Lumens per Watt(Efficacy)	80	Lm/W
Light Output	160	lm
Light Color(CCT)	6000	K
Beam Angle	120	°(degree)
Color Accuracy(CRI)	70	Ra
Product Weight	16	G
Rating Life	35000	H
Base	GU4	
Input Voltage(DC/AC)	12	V

Model

MR11 2W120-12V White

Luminance Intensity Distribution

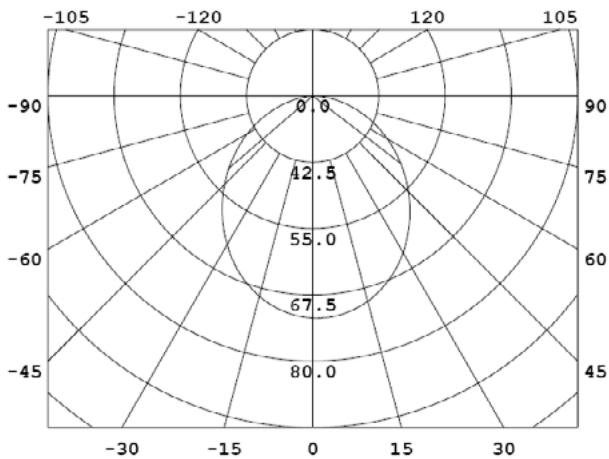

Cone Lux Diagram

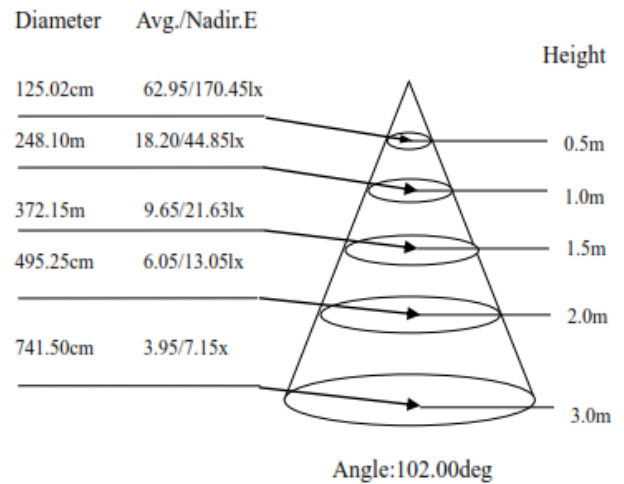

Watts	2	W
Lumens per Watt(Efficacy)	65	Lm/W
Light Output	130	lm
Light Color(CCT)	3000	K
Beam Angle	120	°(degree)
Color Accuracy(CRI)	80	Ra
Product Weight	16	G
Rating Life	35000	H
Base	GU4	
Input Voltage(DC/AC)	12	V

Model

MR11 2W120-12V Warm White

Luminance Intensity Distribution

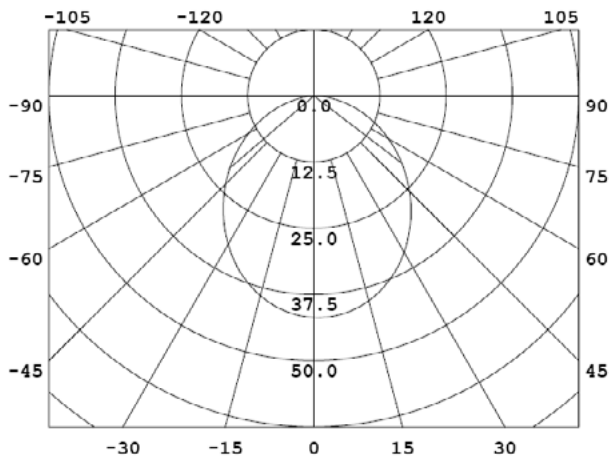

Cone Lux Diagram

