

- AC phase-cut DALI dimmer, one DALI address, one channel output.
- In accordance with DALI standard protocol IEC 62386-102, IEC 62386-207 and in compliance with DALI products from other international incorporation.
- Numeric display, set DALI address, dimming mode, dimming curve, minimum brightness by button.
- DALI address can be manually assigned and shown in digital display or automatically assigned by DALI master.
- Reverse-phase dimming or forward-phase dimming selectable.
- Linear dimming or logarithmic dimming selectable.
- Connect with external push switch to achieve on/off and 0-100% dimming function.
- To dim and switch single color dimmable LED lamps, traditional incandescent and halogen lights.
- Over-heat protection, recover automatically.
- Available in white or black.

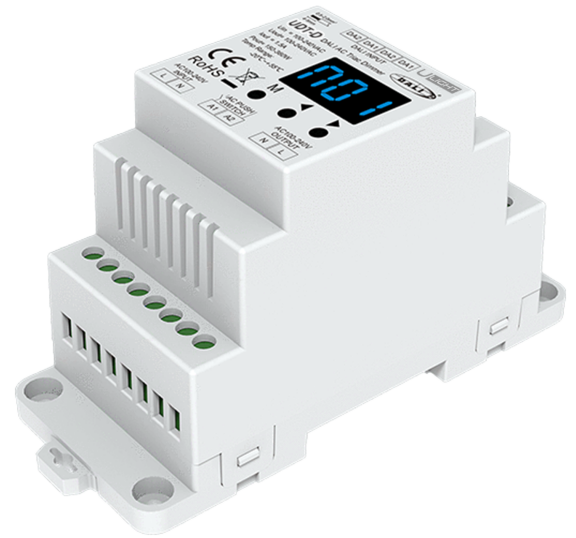

Technical Parameters

Input and Output		Dimming data		Safety and EMC	
Input voltage	100-240VAC	Input signal	DALI, AC Push	EMC standard (EMC)	ETSI EN 301 489-1 V2.2.3 ETSI EN 301 489-17 V3.2.4
Output voltage	100-240VAC	Dimming curve	Linear / Logarithmic	Safety standard	EN 62368-1:2020+A11:2020
Output current	Max 1.5A	Dimming level	256 level	Certification	CE, EMC, DALI-2
Output power	150-360W	Dimming range	0-100%	Package	
Warranty and Protection		Environment		Size	L120 x W78 x H55mm
Warranty	5 years	Operation temperature	Ta:-20°C~+55°C	Gross weight	0.132kg
Protection	Over-heat	Case temperature (Max.)	Tc:+85°C		
		IP rating	IP20		

Mechanical Structures and Installations

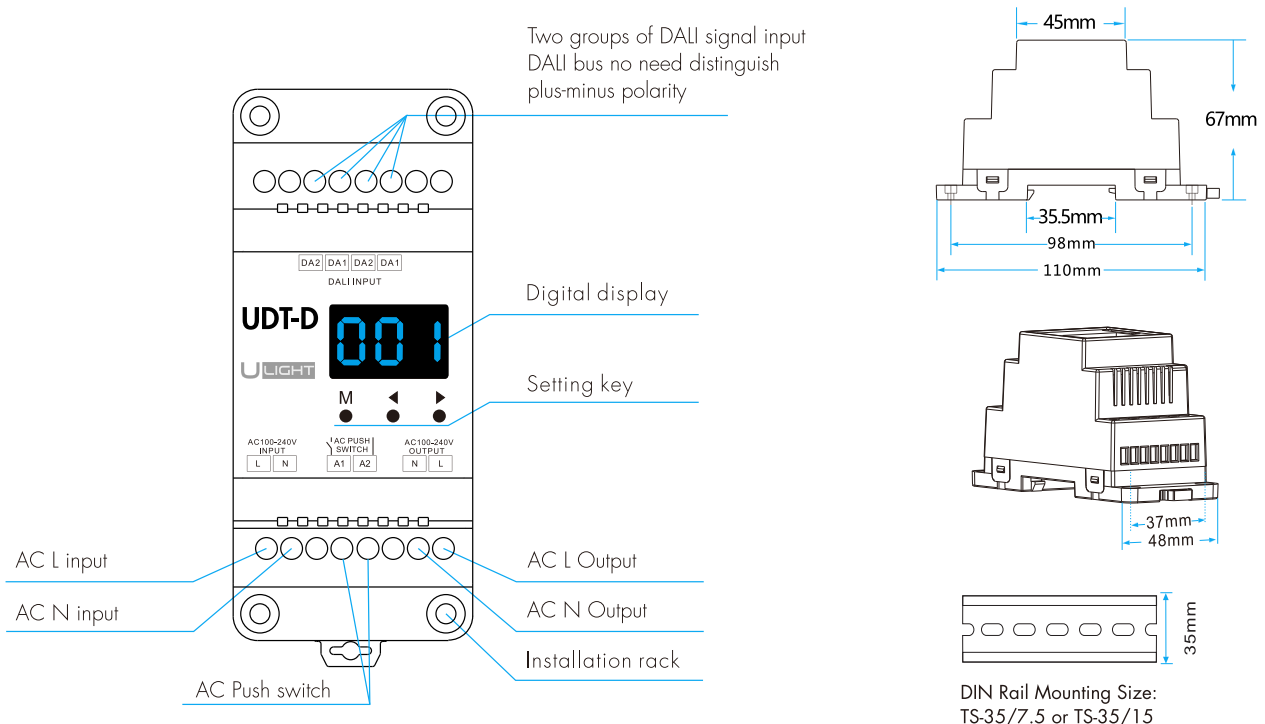

Wiring Diagram

⚠ Caution: Please carefully ensure all wire connections and polarities are correct and secure before applying power, otherwise this controller will be damaged.

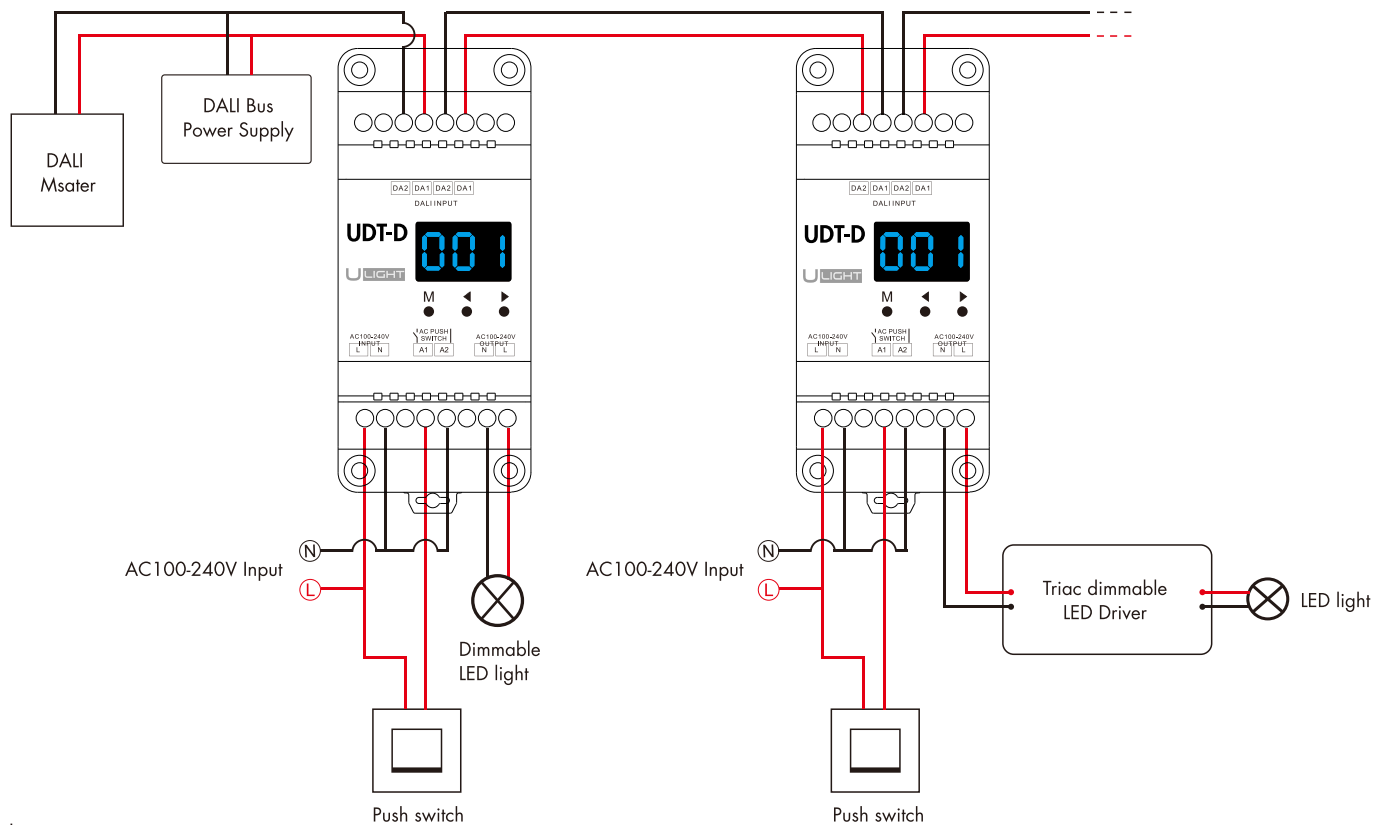

Note:

When calculating the maximum number of load lamps or drivers, the input power or input current parameters of a single lamp or driver must be used, the output power parameters can not be used.

In addition, the maximum surge current of the dimmer is 6.5A, the sum of surge current of multiple dimmable LED drivers should not exceed 2 times. otherwise, the product will be overloaded and damaged.

Operation

Set DALI Address via buttons

- Long press ◀ or ▶ key for 2s, prepare for set the start DALI address, digital display start flashes.
- Short press ◀ or ▶ key to set DALI address, the address can be set from 00~63~FF.
- No DALI address is assigned for the dimmer, digital display shows "AFF".
- Short press M key, or timeout for 10s, quit DALI address setting, digital display stop flashes.

DALI address assigned by DALI masters

DALI address can also be assigned by DALI Master controller automatically.

Please refer to user manuals of compatible DALI Masters for specific operations.

The digital display will show "AAU" when the DALI master is assigning address.

After address is assigned, the digital display will show the start DALI address "Axx", xx is from 00 to 63.

Reverse-phase or forward-phase dimming setting

- Long press M key for 2s, prepare for set the reverse-phase or forward-phase dimming, digital display start flashes.
- Short press ◀ or ▶ key to switch reverse-phase dimming ("C-F") or for ward-phase dimming ("C-R").
- Short press M key, or timeout 10s, quit reverse-phase or forward-phase dimming setting.

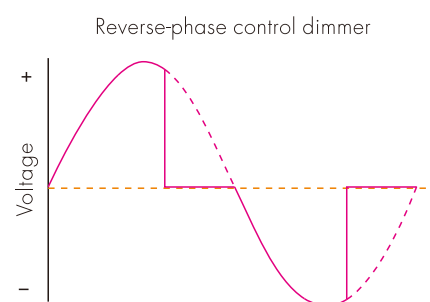
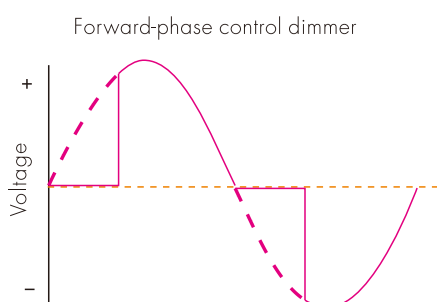

Minimum brightness setting

- Long press M key & ► key for 2s, prepare for set the minimum brightness, digital display start flashes.
- Short press ◀ or ► key to set the minimum brightness, the minimum brightness can be set 00%~40%~FF%, the factory default is 20%.
- When setting the minimum brightness using the DALI master, if the minimum brightness exceeds 40%, digital display "LFF".
- Short press M key, or timeout 10s, quit the minimum brightness setting.

Dimming curve setting

- Long press M key & ◀ key for 2s, prepare for set the dimming curve, digital display start flashes.
- Short press ◀ or ► key to switch linear dimming ("C-L") or logarithmic dimming ("C-E").
- Short press M key, or timeout 10s, quit dimming curve setting.

$$X(n) = \frac{n}{254} \cdot 100[\%]$$

Linear dimming curve

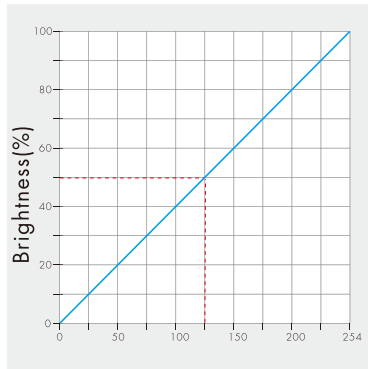

$$X(n) = 10 \frac{n-1}{253/3} - 1$$

Logarithmic dimming curve

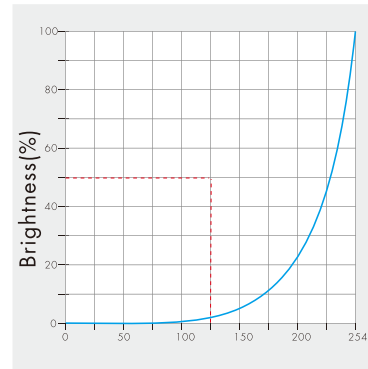

Restore factory default parameter

- Long press ◀ & ► for 2s restore factory default parameter, digital display "RES".
- Factory default parameter: Unassigned DALI address(digital display "AFF"), linear dimming curve, reverse-phase control, the minimum brightness is 20%.

Push-Dim Function

The provided Push-Dim interface allows for a simple dimming method using commercially available non-latching(momentary) wall switches.

- **Short press:**
Turn on or off light.
- **Long press (1-6s):**
Press and hold to step-less dimming,
With every other long press, the light level goes to the opposite direction.
- **Dimming memory:**
Light returns to the previous dimming level when switched off and on again, even at power failure.
- **Synchronization:**
If more than one controller are connected to the same push switch, do a long press for more than 10s, then the system is synchronized and all lights in the group dim up to 100%.
This means there is no need for any additional synchrony wire in larger installations.
We recommend the number of controllers connected to a push switch does not exceed 25 pieces, The maximum length of the wires from push to controller should be no more than 20 meters.

Compatible Load Types

Load Type	Maximum Load	Remarks
Dimmable LED lamps	200W @ 220V 100W @ 110V	Due to variety of LED lamp designs, maximum number of LED lamps is further dependent on power factor result when connected to dimmer.
Triac Dimmable LED drivers	200W @ 220V 100W @ 110V	Maximum permitted number of drivers is 200W divided by driver nameplate power rating, and make sure the surge current is no more than 2 times 65A.
Incandescent lighting, HV Halogen lamps	400W @ 220V 200W @ 110V	

Safety & Warnings

- DO NOT install with power applied to device.
- DO NOT expose the device to moisture.