

- Concealed PIR motion sensing head.
- Sensor head detection distance: 3-4 meters, detection angle: 120°.
- Powered by low voltage 5VDC, output 5V level signal.
- Bilateral snap design for easy installation.
- Used for lighting stairs, garages, cabinets, closets, wine cabinets and more.



CE RoHS LVD

### Wiring Diagram

- Power supply using constant voltage power supply + junction box

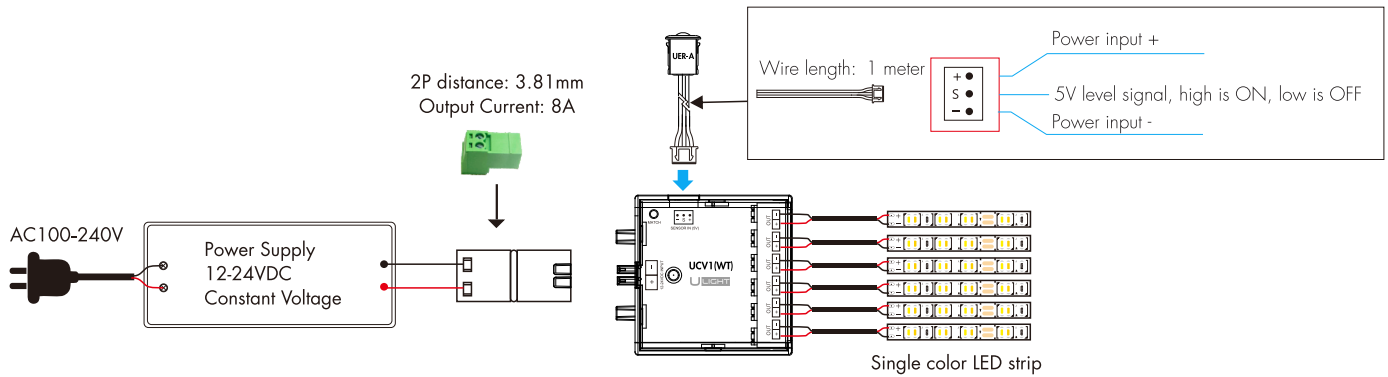

- Power supply using cabinet constant voltage power supply + junction box

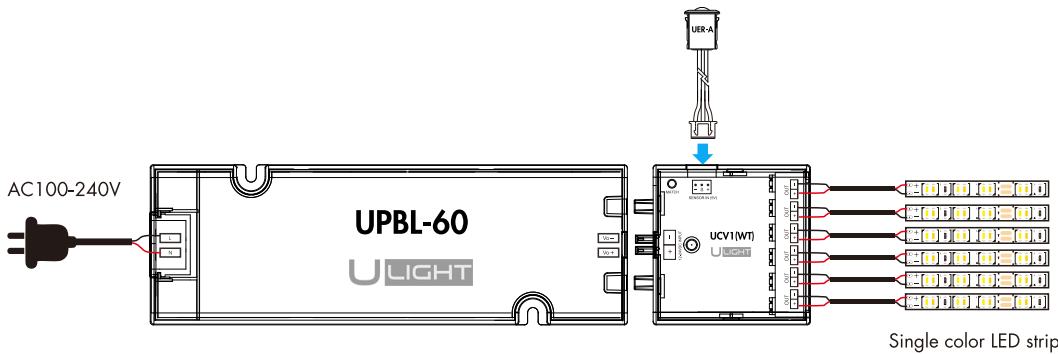

### Sensing head installation

Wall mounting:

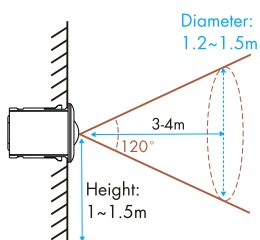

Ceiling mounting:

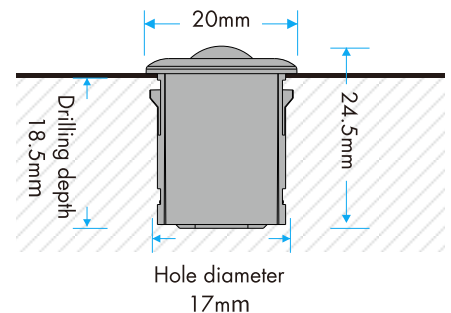
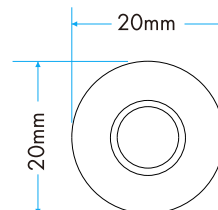
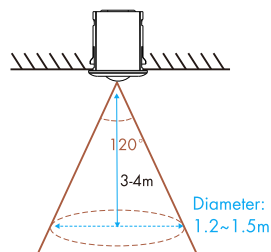

## Sensing head application

---

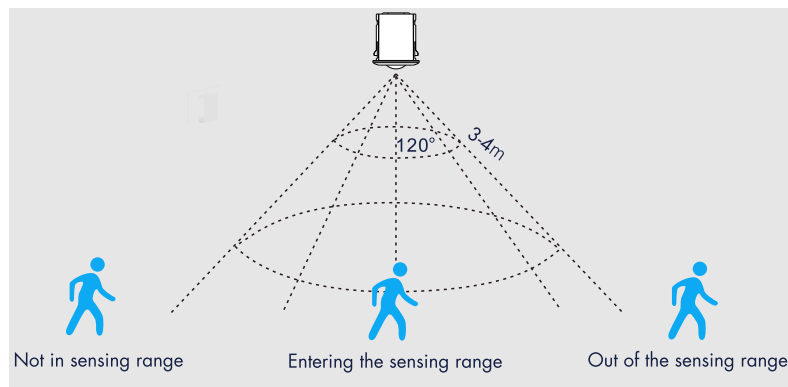

When people enter the sensing range, the light turn on;  
when people exit the sensing range, the light turn off after 30 seconds.

## Installation precaution

---

1. Recommended for wall mounting.
2. If the sensing head is exposed to direct sunlight, interference signal will be introduced.
3. The sensing head should be installed in a dry environment and keep away from windows, air conditioner and fans.
4. Make sure that the sensing head stays away from heat source, such as countertops, kitchen appliances which generate hot steam, walls and windows in direct sunlight, air conditioner, heating, refrigerators, stoves and so on.
5. We recommended the wall-mounted installation height is 1-1.5 meters and the ceiling mounting height is no more than 3 meters.
6. There should not be shelter(screen, furniture, large bonsai) within the range of detection.