

AC Switch

- High-voltage AC input, 4-channel high-voltage AC switch output.
Per channel output current 5A, maximum total output power 1200W.
- Tuya smart APP cloud control, support turn on/off zone light, one key turn on/off all lights, delay turn on/off light, timer run and restart status setting.
- Voice control, support for Amazon Alexa, Google Assistant, Tmall Genie and Xiaodu smart speakers.
- Suitable for turning on/off single color LED lights, traditional incandescent and halogen lights.
- Set 1, 2, 3, 4 channel switch output by DIP switch.
- Match with RF 2.4G remote control optional.

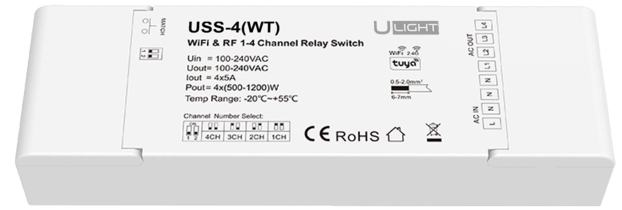

CE RoHS RED

Technical Parameters

Input and Output		Safety and EMC		Environment	
Input voltage	100-240VAC	EMC standard(EMC)	ETSI EN 301 489-1 V2.2.3 ETSI EN 301 489-17 V3.2.4	Operation temperature	Ta: -20°C ~ +55°C
Output voltage	100-240VAC	Safety standard	EN 61347-1:2015+A1:2021 EN 61347-2-13:2014+A1:2017	Case temperature (Max.)	Tc: +75°C
Output current	4CH, 5A/CH	Radio equipment(RED)	ETSI EN 300 328 V2.2.2	IP rating	IP20
Output power	500-1200W/CH	Certification	CE, EMC, RED	Package	
Input signal	WiFi + RF 2.4GHz	Warranty	5 years	Size	L187 x W60 x H40mm
Control distance	30m(Barrier-free space)			Gross weight	0.192kg

Mechanical Structures and Installations

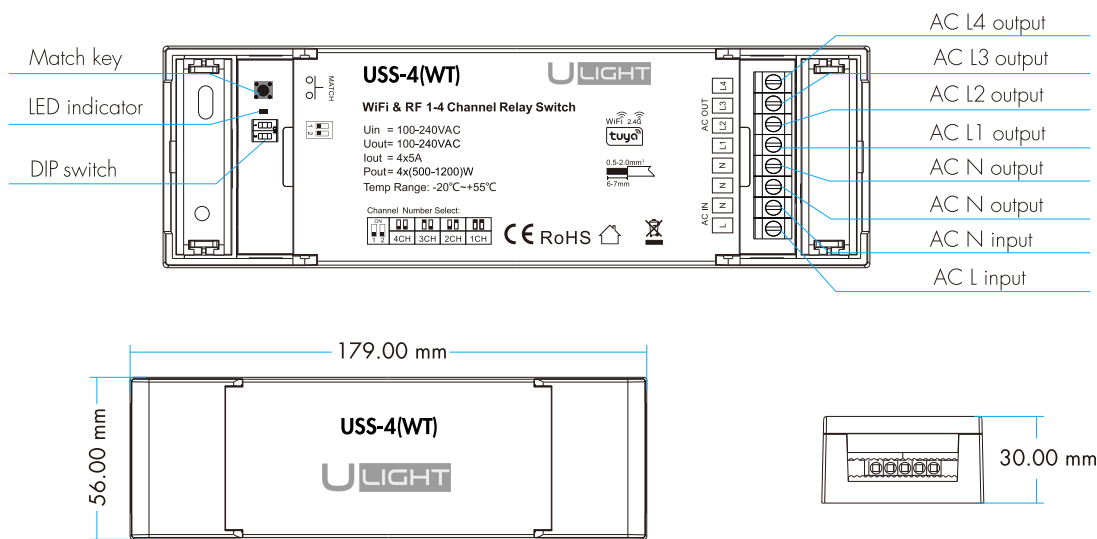

DIP Switch Setting

Set 1/2/3/4 channel switch output by DIP switch:

	1 channel output, L1, L2, L3, L4 synchronized switch, match with single-zone or multiple-zone remote control optional.
	2 channel output, L1 and L3 synchronized switch, L2 and L4 synchronized switch, match with 2 zones remote control optional.
	3 channel output, L1, L2, L3 independently switch, L4 invalid, match with 4 zones remote control optional.
	4 channel output, L1, L2, L3, L4 independently switch, match with 4 zones remote control optional.

Wiring Diagram

Taking set to 4 channel output and match with 4-zone switch remote control for example, zones 1,2,3, 4 of the remote control correspond to L1, L2, L3, L4 switch respectively.

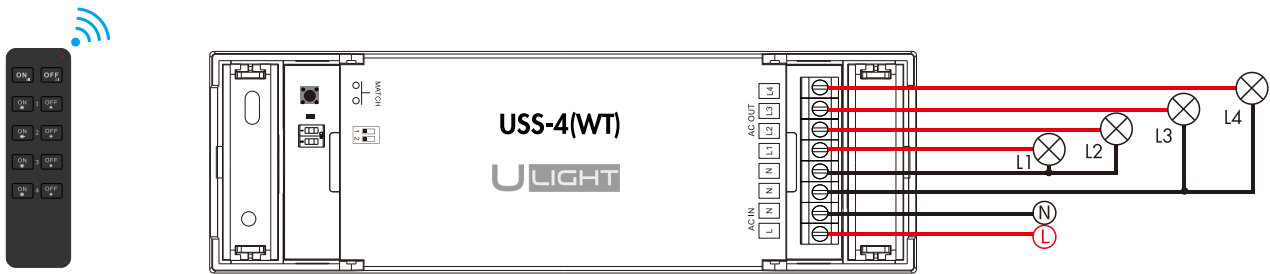

System Wiring

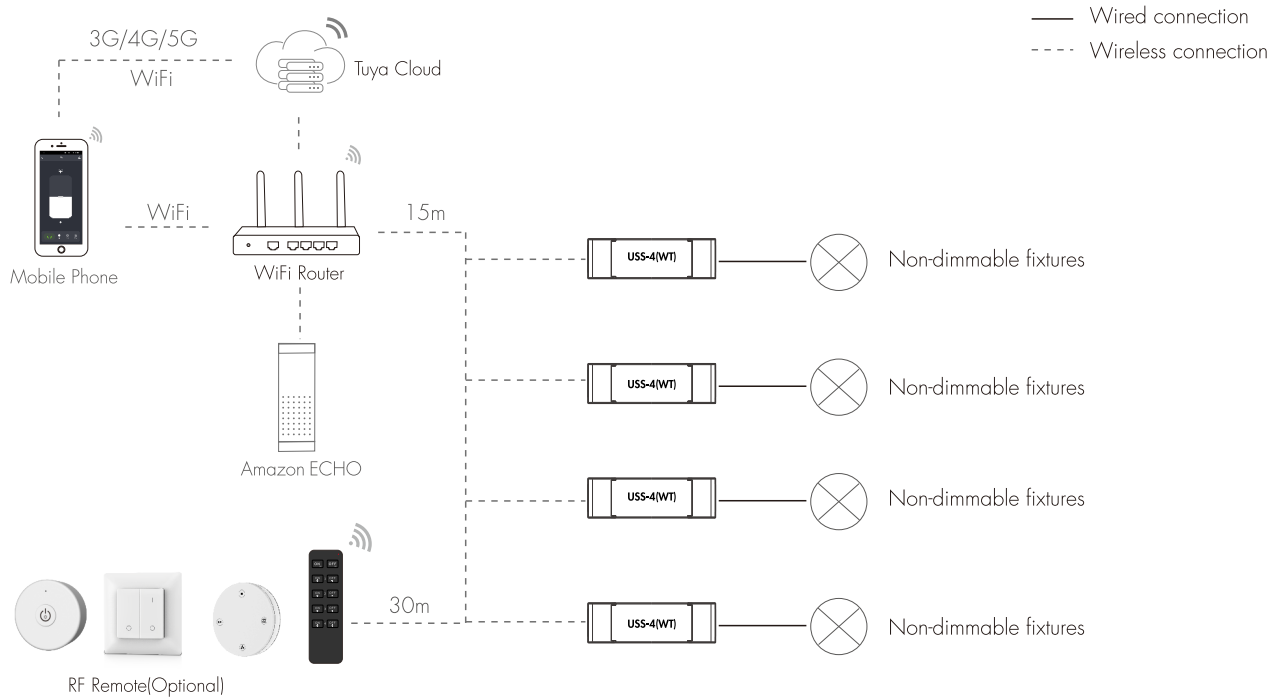

NOTE:

1. The above distance is measured in spacious(no obstacle) environment, Please refer to the actual test distance before installation.
2. Please check if the WiFi router net in 2.4G band, the 5G band is not available, and do not hide your router network.
3. Please keep the distance between controller and router close, and check the WiFi signals.
4. WiFi signal strength detection: open the main interface of social security, click enter the device interface, click "check device network" for testing.

Tuya Smart APP Network Connection

Search for "Tuya Smart/Smart Life APP" in the app store, or scan the QR code on the right to download the APP. Register and login after installation.

Below three methods are available to clear the previous network connection and enter Tuya WiFi Smart config mode with RUN indicator flashing fast:

- ① Quickly short press match key twice
- ② Change 1,2,3,4 channel output by DIP switch
- ③ Long press match key for 5s.

Repeat power on and off for 5 consecutive times, also clear previous network connection, enter WiFi Smart config mode, the output LED will flash 10 times.

Find the 1-SWITCH device (or 2-SWITCH, 3-SWITCH, 4-SWITCH device) in Tuya smart APP and add.

If Tuya smart APP network connection succeed, RUN indicator will flash Slowly 3 times.



Smart Life



Tuya Smart

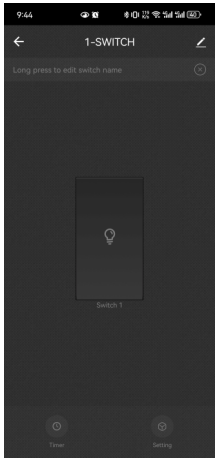

1 channel switch

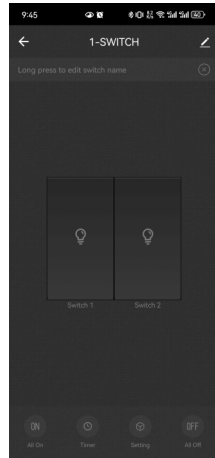

2 channel switch

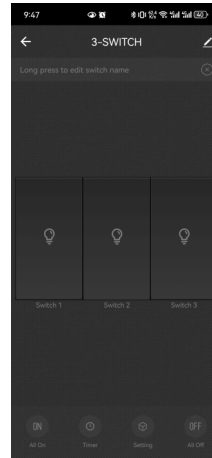

3 channel switch

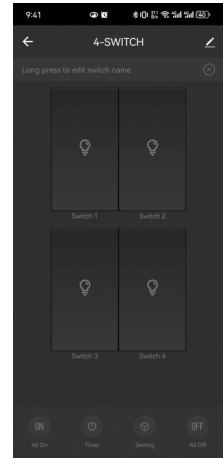

4 channel switch

1,2,3,4 channel switch interface:

Short press switch 1,2,3,4 key to turn on/off 1,2,3,4 zone lights.

Short press ON to turn on all channel lights.

Short press OFF to turn off all channel lights.

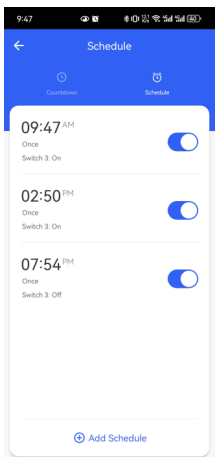

Schedule:

The countdown key can turn on or turn off light automatically in the next 24 hours.

The Schedule key can add multiple timers to turn on or turn off light according to different time periods.

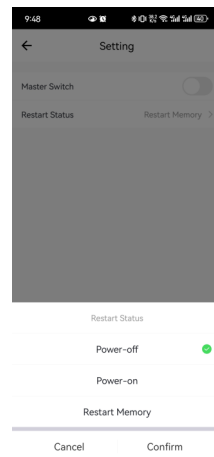

Setting interface:

Master switch: One key to turn on or off the zone light.

Restart Status: Power off, power on, restart memory.

Match with RF Remote Controller (Optional)

There are two ways to match/delete:

Use Match key

Match:

Short press match key, the LED indicator flash slowly.
Immediately press on/off key (single zone remote)
or zone key (multiple zone remote) of the remote.
The LED indicator fast flash 3 times means match is successful.

Delete:

Press and hold match key for 10s to delete all match, The LED indicator fast flash a few times means all matched remotes were deleted.

Use Power Restart

Match:

Switch off the power, then switch on power, repeat again.
Immediately short press on/off key (single zone remote)
or zone key (multiple zone remote) 3 times on the remote.
The LED indicator blinks 3 times means match is successful.

Delete:

Switch off the power, then switch on power, repeat again.
Immediately short press on/off key (single zone remote)
or zone key (multiple zone remote) 5 times on the remote.
The light indicator blinks 5 times means all matched remotes were deleted.

Recommended Remote Controls



UR1-1

Single zone switch remote control



UPF1-2

2 zone switch remote control



URK4-U

4 zone switch remote control



URU4

4 zone switch remote control