

WiFi + RF + Sensor Synchronous DIM 6 CH LED Control Box

UCV1(WT)

a010110



- Dimming interface: WiFi, RF Wireless and sensor
- Tuya smart APP cloud control, support brightness adjust, delay turn on/off light, timer run, scene edit function
- Voice control, support for Amazon Alexa, Google Assistant, Tmall Genie and Xiaodu voice assistant
- Match with RF 2.4G single zone or multiple zone dimming remote control
- Match with a variety of sensor head
- 12-24VDC Input
- 6 channel synchronous constant voltage output, Max. total output power 60W
- Output PWM frequency: 8000Hz
- Ultra-thin design, light weight and high efficiency
- Light on/off fade time 3s selectable
- Suitable for indoor LED lighting application
- 5 Year, 50,000hr warranty

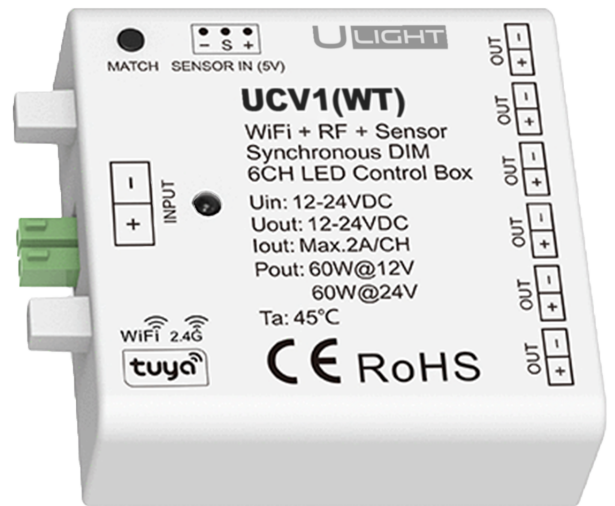

Applications

- Suitable for cabinet LED strip.

Mechanical Structures and Installations

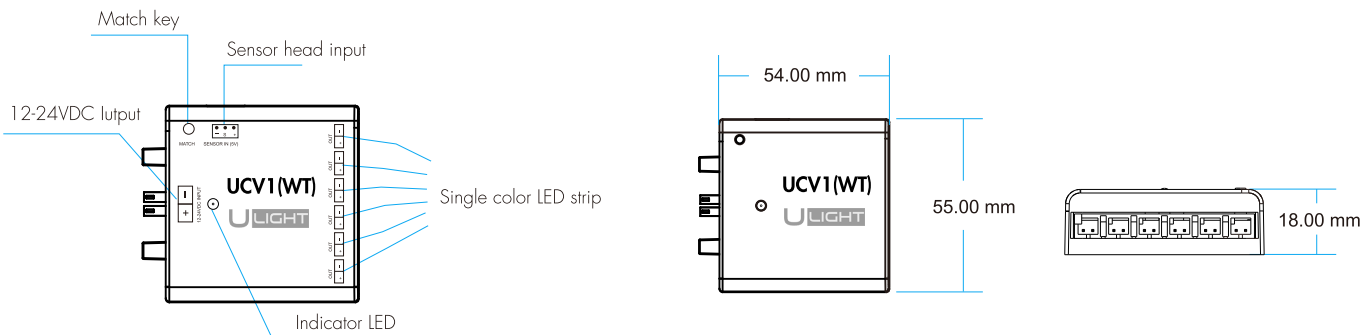

System Wiring

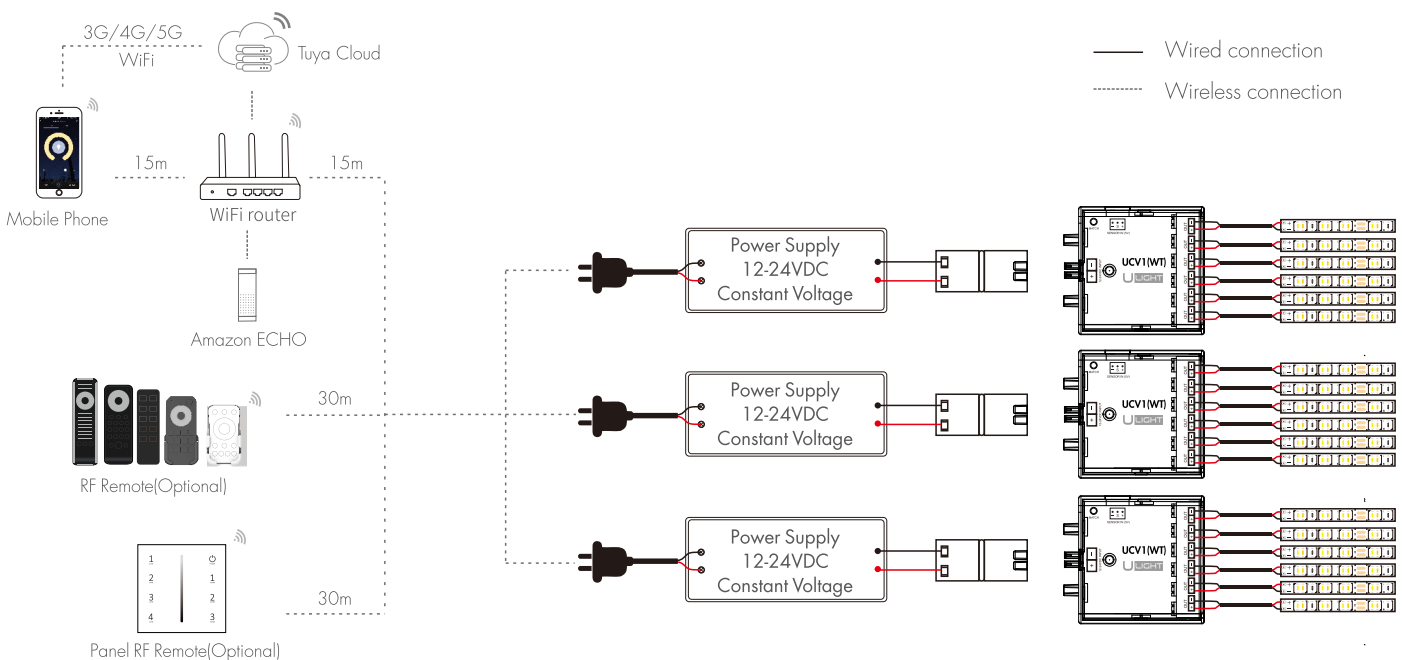

Note:

1. The above distance is measured in spacious (no obstacle) environment, Please refer to the actual test distance before installation.
2. Please check if the WiFi router net in 2.4G band, the 5G band is not available, and do not hide your router network.
3. Please keep the distance between LED driver and router close, and check the WiFi signals.

Wiring Diagram

1. Use alone, powered by constant voltage power supply

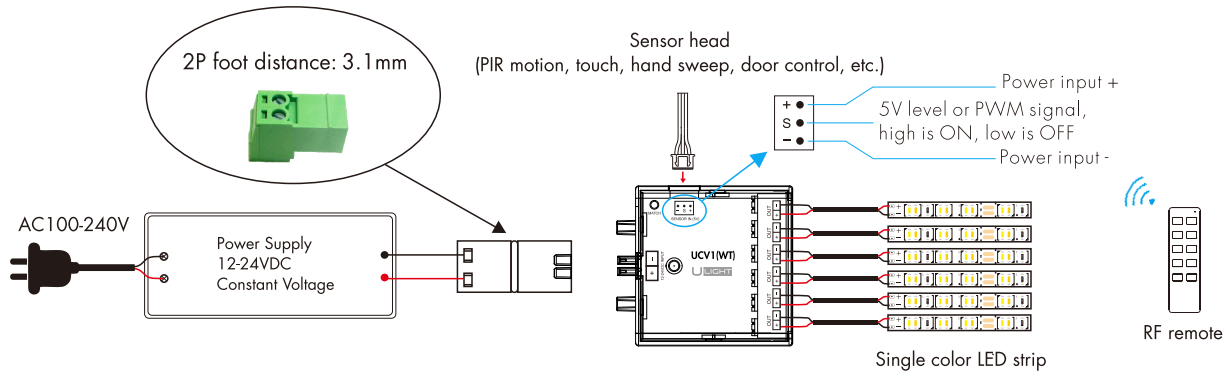

2. Matching cabinet LED driver use

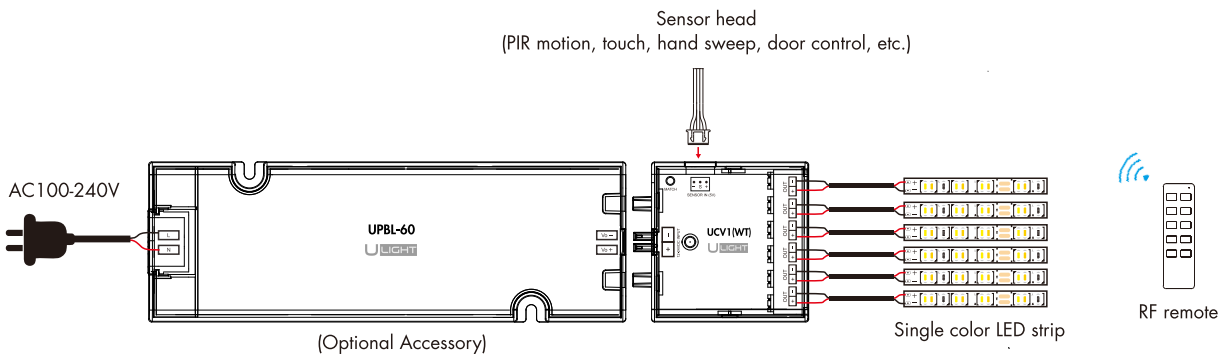

Note: The sensor head input PWM frequency range is 500-2000Hz.

Match Remote Control

The control box can match with RF 2.4G dimming remote control optionally by default, except PIR motion sensor input. For PIR motion sensor input, please long press the Match key 20s to disable the RF remote match function. For other sensor input, please long press the Match key 10s to enable the RF remote match function. The user can choose the suitable match/delete ways. Two options are offered for selection:

Use Match key

Match:

Short press match key, immediately press on/off key (single zone remote) or zone key (multiple zone remote) of the remote.

Delete:

Press and hold match key for 10s to delete all match, The light blinks 5 times means all matched remotes were deleted.

Use Power Restart

Match:

Switch off the power, then switch on power, repeat again. Immediately short press on/off key (single zone remote) or zone key (multiple zone remote) 3 times on the remote. The light blinks 3 times means match is successful.

Delete:

Switch off the power, then switch on power, repeat again. Immediately short press on/off key (single zone remote) or zone key (multiple zone remote) 5 times on the remote. The light blinks 5 times means all matched remotes were deleted.

Tuya Smart APP Network Connection and Operation

Please download the corresponding tuya/smart life APP according to your region. Press and hold Match key for 2s, or push twice Match key fastly, Clear previous network connection, enter Smart config mode, the blue LED indicator flash fastly.

Press and hold Match key for 5s:

Clear previous network connection, enter AP config mode, the blue LED indicator flash slowly. If smart config failed, please try AP config.

Repeat power off and on for 5 consecutive times fastly, also clear previous network connection, enter Smart config mode, the output LED will flash 10 times.

If Tuya smart APP network connection succeed, the blue LED indicator will stop flash, and in Tuya APP, you can find DIM device.

Tuya smart APP interface operation:

Touch brightness slide to adjust brightness.

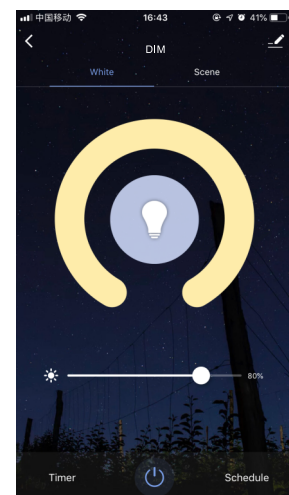

Light On/Off Fade Time

Long press match key 10s, then short press match key 3 times, the light on/off time will be set to 3s, the indicator light blink 3 times.
 Long press match key 15s, restore factory default parameter, the light on/off time also restore to 0.5s.

Installation Precautions

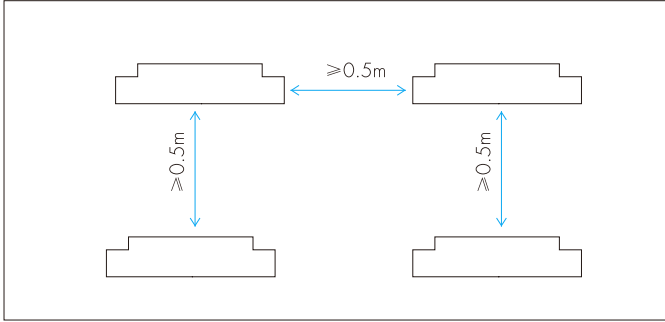

Please do not stack the products.

The distance between two products should be $\geq 0.5m$, so as not to affect heat dissipation and lifespan of the products.

Dimming Curve

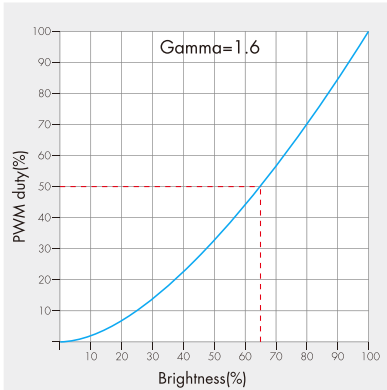

Failure Analysis and Troubleshooting

Fault	Cause	Solution
The light can not be turned on	<ol style="list-style-type: none"> No power Wrong wiring 	<ol style="list-style-type: none"> Check the power supply Connection test
Remote control nonresponse	<ol style="list-style-type: none"> Run out of battery Beyond remote control range No matching 	<ol style="list-style-type: none"> Replace the battery Move the remote to controller closer Match the remote to LED driver
Hiccup flashing	Overload	Check the power of the light
Controlled by other remote	Wrong pairing	Delete all pairing and pair with remote again
Multiple LED controllers are out of sync	Inconsistent fade on/off time	Set the same fade on/off time

Packing List

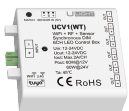

LED Control Box
1 pcs

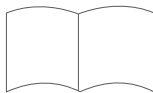

User Manual
1 pcs



2P Terminal
1 pcs



Slotted
screwdriver
1 pcs