

# LED PROFILES

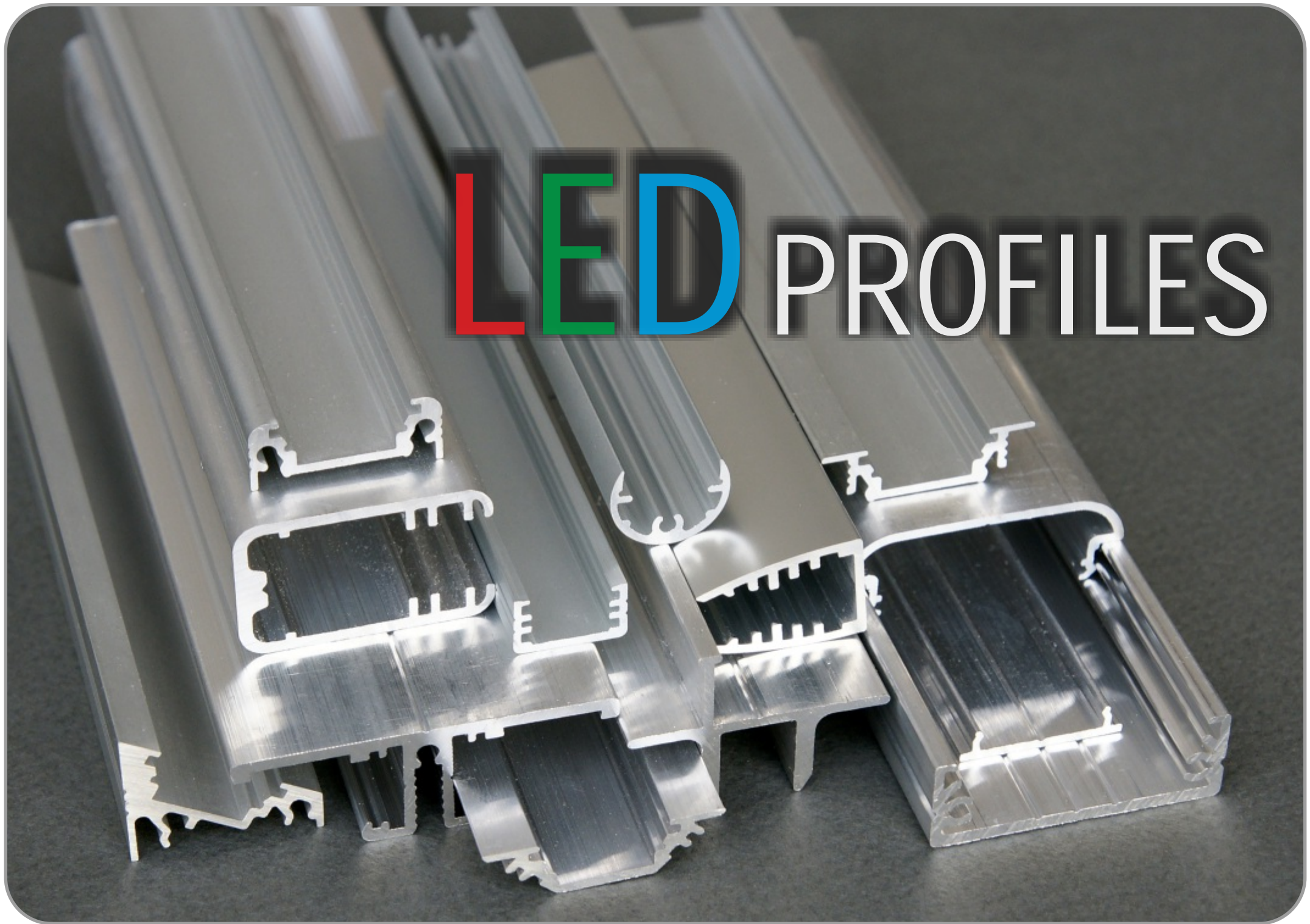

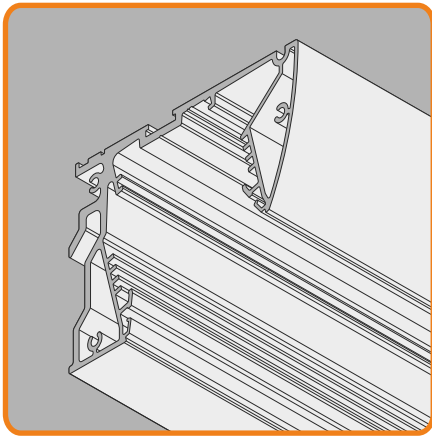

# profile LED SHELF MULTI

can be used as the shelf or cables hiding cover giving decorative and uniform light; accessories for cables hiding click-on cover profile

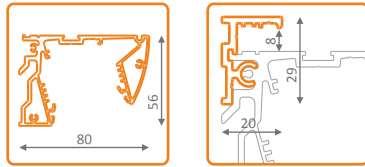

anodized aluminium

standard lengths: 500, 1000, 2000mm;  
max. length 4000mm; length above 2000mm - own collection

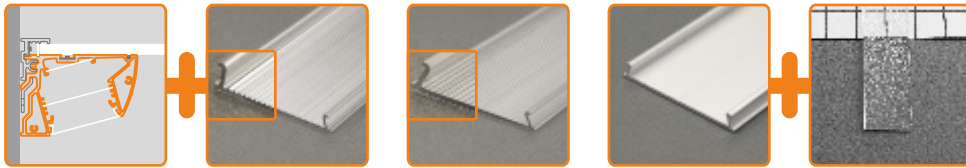

profile LED SHELF MULTI anodized 500mm <b>under the order</b> 1000mm <b>under the order</b> 2000mm <b>017288</b>	cover standard 500mm <b>under the order</b> 1000mm <b>under the order</b> 2000mm <b>under the order</b>	cover narrow 500mm <b>under the order</b> 1000mm <b>under the order</b> 2000mm <b>017323</b>	cover anodized 500mm <b>under the order</b> 1000mm <b>under the order</b> 2000mm <b>016990</b>	cover transparent 500mm <b>under the order</b> 1000mm <b>under the order</b> 2000mm <b>016986</b>
--	---	--	--	---

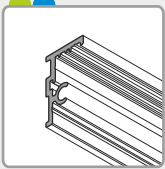

glass fixing  
500 - **under the order**  
1000 - **under the order**  
2000 - **017291**

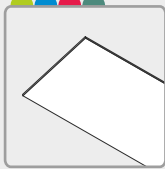

LED mounting  
500 - **under the order**  
1000 - **under the order**  
2000 - **017290**

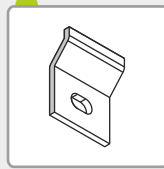

holder galvan.  
**017301**

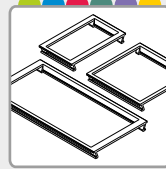

socket frame  
0,5 - **017300**  
1 - **017303**  
2 - **017302**

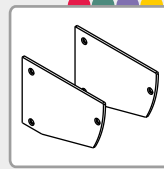

ending  
**017297**

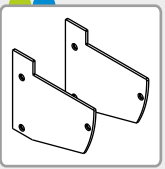

ending shelf  
**017296**

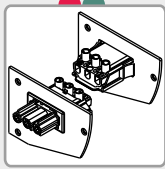

ending connector  
**017299**

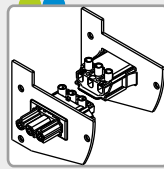

ending connector shelf  
**017298**

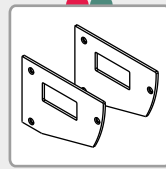

ending pass through  
**017309**

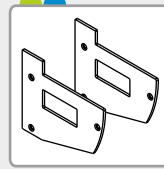

ending pass through shelf  
**017308**



sockets



switches

## applications

### 1 shelf

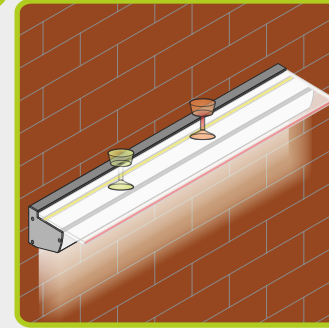

### 2 profile with glass

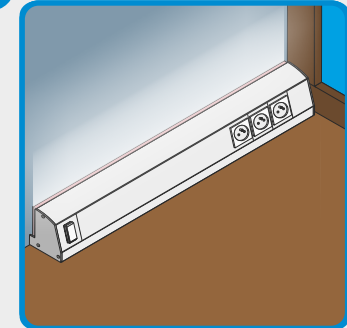

### 3 floor profile

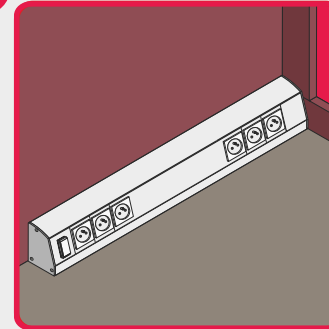

### 4 undercabinet profile

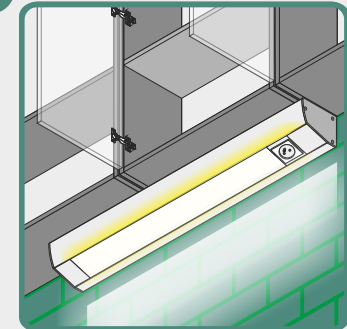

### 5 office profile

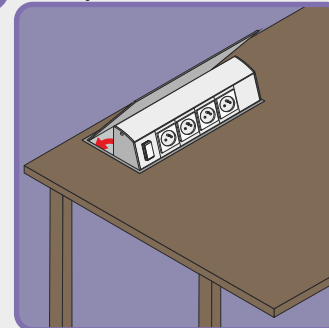

### 6 extension lead

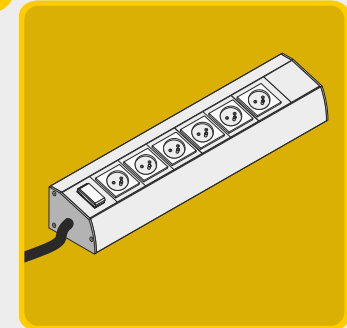

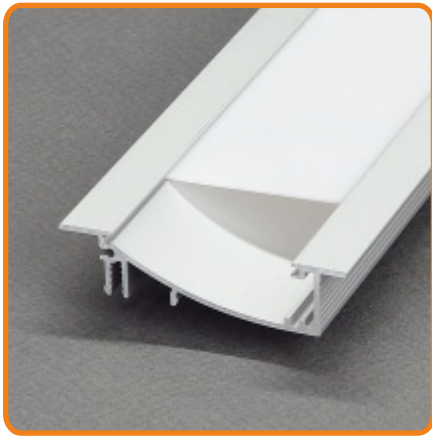

# profile LED SWALL

extremely slim, fit to the plasterboard; does not interfere with the construction of the plasterboard; uniform, smooth light; optional extra diffuser; can be mounted to the furniture, walls or floor profiles using the mounting plates (easy click system) or directly by screwing or using the glue (pasting)

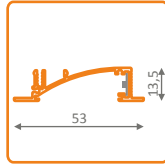

raw aluminium (optional painting) or anodized aluminium

standard lengths: 500, 1000, 2000mm;  
max. length 4000mm; length above 2000mm - own collection

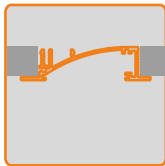

profile LED SWALL  
- raw aluminium:  
500mm  
1000mm  
2000mm  
- anod.:  
500mm **under the order**  
1000mm **under the order**  
2000mm **016968**



ending /set= 2pcs/  
**017337**

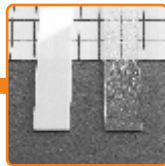

cover white	cover transparent
500mm	500mm
<b>under the order</b>	<b>under the order</b>
1000mm	1000mm
<b>under the order</b>	<b>under the order</b>
2000mm	2000mm
<b>017315</b>	<b>017314</b>

**optional mounting:**



mounting plate  
/set = 2pcs/  
**017336**



flexible mounting plate  
/set = 2pcs/  
**017339**



mounting plate  
spring  
**017285**

**optional connector**



connector  
**017338**

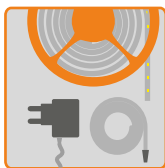

LED strip + cable  
+ power supply  
--> pages 21 - 24

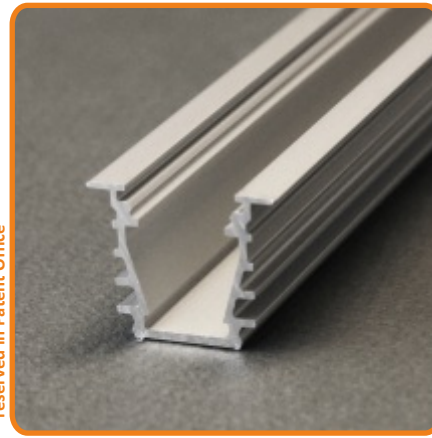

# profile LED DEEP

the profile can be installed in the surface, furniture or tile gap, in the wall or ceiling; the profile gives effect of lighting line; 6 different covers;

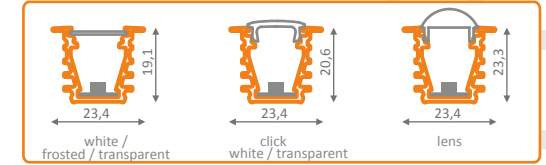

anodized aluminium

standard lengths: 500, 1000, 2000mm;  
max. length 4000mm; length above 2000mm - own collection

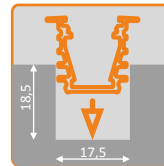

profile LED DEEP  
anod.:  
500mm **under the order**  
1000mm **under the order**  
2000mm **016971**



ending /set=2pcs/  
**017333**

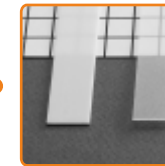
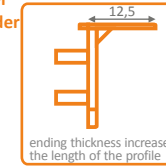

cover white	cover frosted	cover transparent
500mm	500mm	500mm
1000mm	1000mm	1000mm
2000mm	2000mm	2000mm
<b>017319</b>	<b>017318</b>	<b>017313</b>

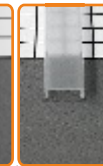

cover click transparent	cover click white
500mm	500mm
1000mm	1000mm
2000mm	2000mm
<b>017317</b>	<b>017382</b>

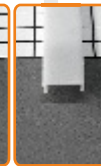

cover lens 60°
500mm
1000mm
2000mm
<b>017312</b>

**optional mounting:**



mounting plate  
**017336**



flexible mounting plate  
**017339**



connector  
**017338**

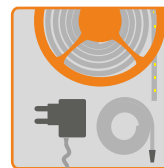

LED strip + cable  
+ power supply  
--> pages 21 - 24

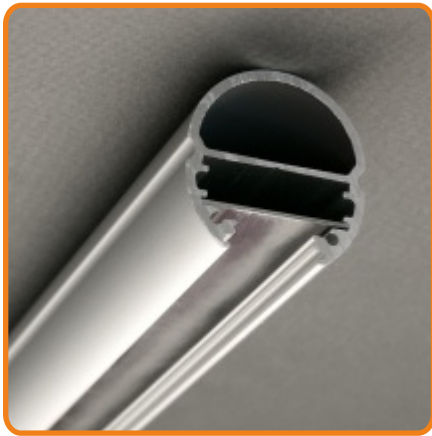

# profile LED OVAL

a stick to hang clothes;  
fitting to furniture's wall  
by using mounting holder OV;  
the lighting of wardrobe's inside

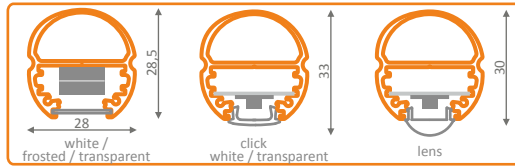

anodized aluminium

standard lengths: 500, 1000, 2000mm;  
max. length 4000mm; length above 2000mm - own collection

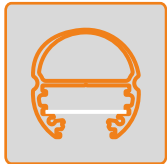

profile LED OVAL  
anod.:  
500mm **under the order**  
1000mm **under the order**  
2000mm **017306**



holder side  
/set= 2pcs/  
**017381**

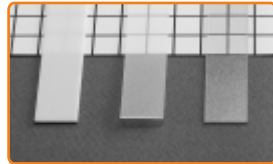

cover white  
500mm  
1000mm  
2000mm  
**017319**



cover frosted  
500mm  
1000mm  
2000mm  
**017318**

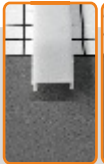

cover transparent  
500mm  
1000mm  
2000mm  
**017313**



cover click transparent  
500mm  
1000mm  
2000mm  
**017317**



cover click white  
500mm  
1000mm  
2000mm  
**017382**



cover lens 60°  
500mm  
1000mm  
2000mm  
**017312**



optional mounting:



holder simple  
/set= 2pcs/  
**017269**

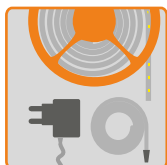

LED strip or  
+ cable + power supply  
---> pages 21 - 24

### example applications

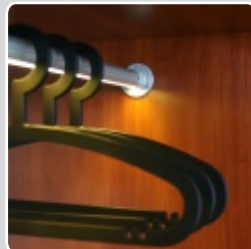
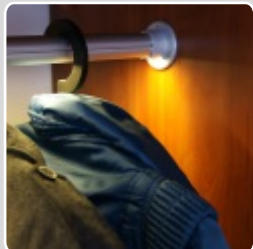

profile is fixed by mounting holder OV to wardrobe's walls;  
LED strip 120 pts/m warm white



# profile LED CORNER-VF

corner profile 45° used in cabinets corners  
profile can be mounted on a surface by screws  
or inside a surface by fitting glue  
perfect fitting of a cover

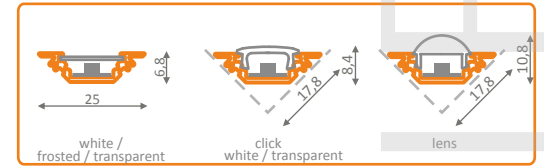

anodized aluminium

standard lengths: 500, 1000, 2000mm;  
max. length 4000mm; length above 2000mm - own collection

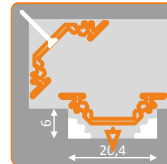

profile LED CORNER-VF  
anod.:  
500mm **under the order**  
1000mm **under the order**  
2000mm **016970**



ending /set= 2pcs/  
**017341**

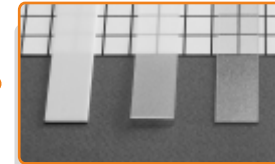
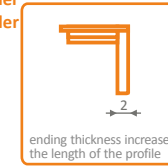

cover white  
500mm  
1000mm  
2000mm  
**017319**

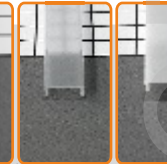

cover frosted  
500mm  
1000mm  
2000mm  
**017318**



cover transparent  
500mm  
1000mm  
2000mm  
**017313**

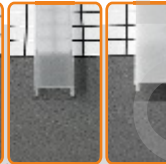

cover click transparent  
500mm  
1000mm  
2000mm  
**017317**



cover click white  
500mm  
1000mm  
2000mm  
**017382**



cover lens 60°  
500mm  
1000mm  
2000mm  
**017312**

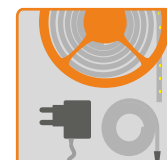

LED strip + cable  
+ power supply  
---> pages 21 - 24



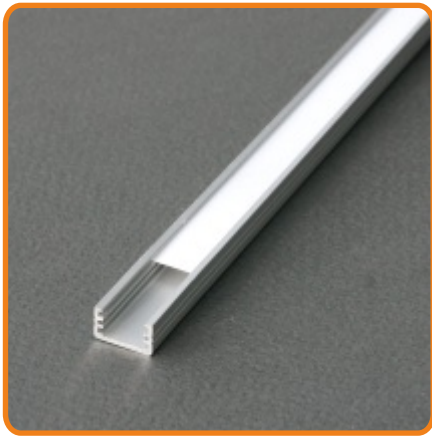

# profile LED SLIM

the smallest profile for LED strip 8mm wide, which can be mounted on the surface; various applications

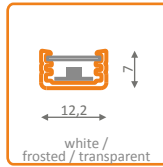

raw aluminium (optional painting) or anodized aluminium

standard lengths: 500, 1000, 2000mm;  
max. length 4000mm; length above 2000mm - own collection

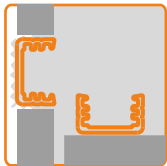

profile LED SLIM  
- raw aluminium:

500mm **under the order**  
1000mm **under the order**  
2000mm **under the order**  
- anod.:  
500mm **under the order**  
1000mm **under the order**  
2000mm **under the order**



ending /set= 2pcs/  
**under the order**

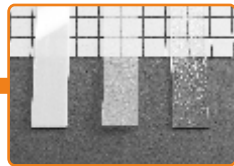
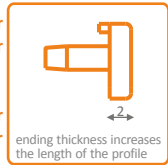

cover white cover frosted cover transparent

500mm	500mm	500mm
1000mm	1000mm	1000mm
2000mm	2000mm	2000mm

optional mounting:



holder simple  
/set = 2pcs/  
**under the order**



flexible mounting plate  
SL /set = 2pcs/  
**under the order**

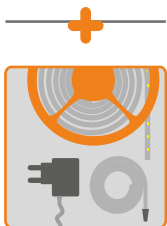

LED strip + cable  
+ power supply  
---> pages 21 - 24

example applications

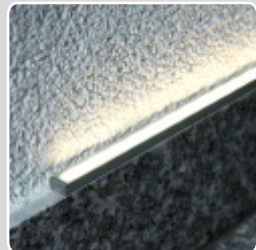

profile mounted on the socle with warm white light

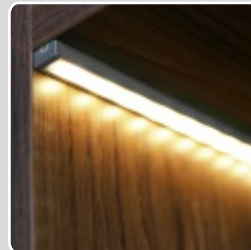
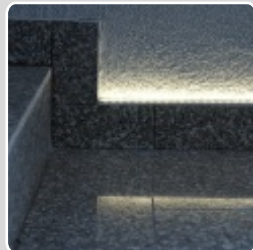

profile mounted in the furniture;  
warm white light



# profile LED BACK

profile can be mounted on a wall or in a cupboard, mounting plate SU/GR/CO can be applied; two-way glow of light; decorative lighting

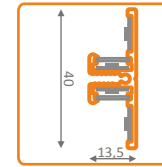

aluminium (optionally painted)

standard lengths: 500, 1000, 2000mm;  
max. length 4000mm; length above 2000mm - own collection

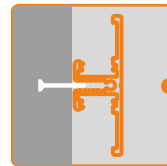

profile LED BACK  
- raw aluminium:

500mm **under the order**  
1000mm **under the order**  
2000mm **under the order**  
- anod.:  
500mm **under the order**  
1000mm **under the order**  
2000mm **under the order**

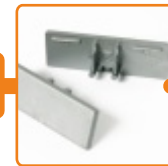

ending /set= 2pcs/  
**017332**

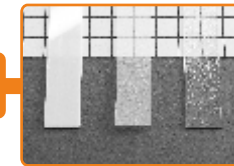
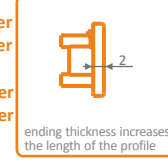

cover white cover frosted cover transparent

500mm	500mm	500mm
1000mm	1000mm	1000mm
2000mm	2000mm	2000mm

optional mounting:



mounting plate  
/set = 2pcs/  
**017336**

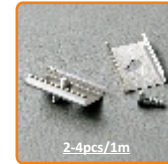

flexible mounting plate  
/set = 2pcs/  
**017339**



connector  
**017338**

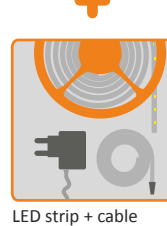

LED strip + cable  
+ power supply  
---> pages 21 - 24

example applications

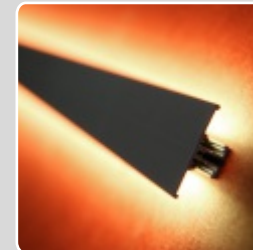

profile mounted on the wall  
with 2pcs warm white LED strips



profile mounted on the wall  
with 2pcs green LED strips



frame mounted around a wall niche;  
first LED strip - red, the other cool white



# profile LED PEN

interior lighting for display cases, images, exposure of trinkets; possibility of directing the light; specially tailored lampshade; various mounting accessories

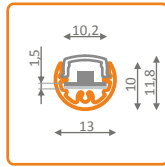

anodized aluminium

standard lengths: 500, 1000, 2000mm;  
max. length 4000mm; length above 2000mm - own collection



profile LED PEN  
- anod.:

500mm **under the order**  
1000mm **under the order**  
2000mm **016980**

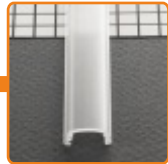

cover

500mm **under the order**  
1000mm **under the order**  
2000mm **017321**

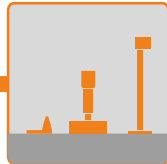

mounting elements

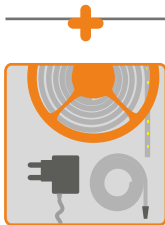

LED strip + cable  
+ power supply  
--> pages 21 - 24

optional mounting:



holder simple  
/set = 2pcs/  
**017286**

## example applications



lighting of company's logo on trade fairs exhibition /SATURN/

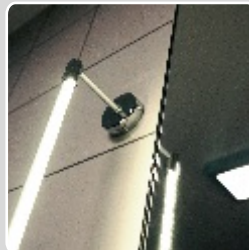

mirror lighting in bathroom with double holder with ceilings; LED strip 3528 120pcs/m

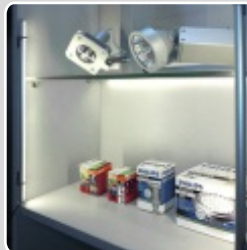

cabinet lighting with flat holder

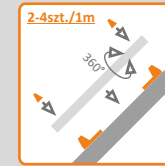

holder flat silver  
**017281**

set consists of 2 holders and 2 endings

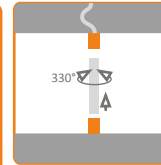

stretcher holder  
chromium  
**017280**

set consists of 2 holders

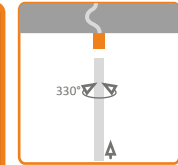
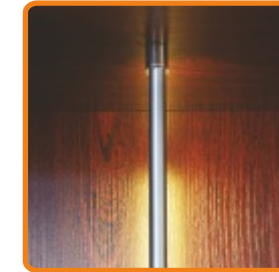

end holder  
chromium  
**017295**

set consists of 1 holder and 1 ending

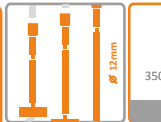
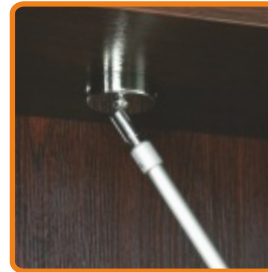

length options:  
"0"  
**017283**  
100mm  
**017293**  
200mm  
**under the order**  
300mm  
**under the order**

holder jointed  
with ceiling  
chromium

set consists of 1 holder and 1 ending

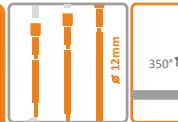
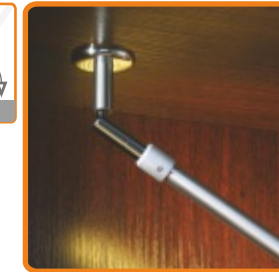

length options:  
"0"  
**017282**  
100mm  
**017292**  
200mm  
**under the order**  
300mm  
**under the order**

holder jointed  
with thread  
chromium

set consists of 1 holder and 1 ending



outriggers  
length options:  
100mm  
**017294**  
200mm  
**under the order**  
300mm  
**under the order**

double holder  
with ceiling  
chromium

set consists of 2 holders

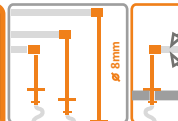
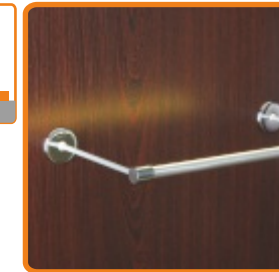

outriggers  
length options:  
100mm  
**017289**  
200mm  
**under the order**  
300mm  
**under the order**

double holder  
with thread  
chromium

set consists of 2 holders

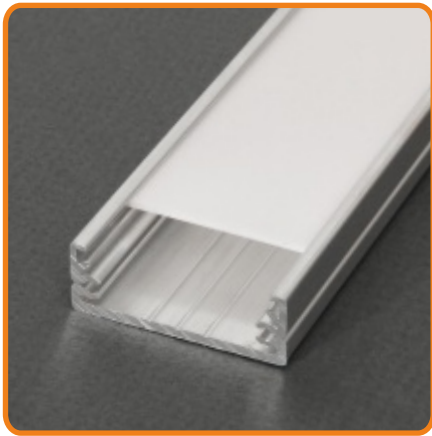

## profile LED WIDE H-11

for mounting on the surface by using a special flat double-sided adhesive tape; the fixture can be used under cupboards e.g. as a lighting of kitchen tops

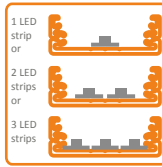
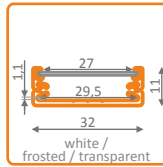

aluminium (optionally painted)

standard lengths: 500, 1000, 2000mm;  
max. length 4000mm; length above 2000mm - own collection

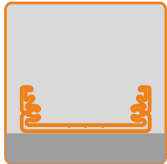

profile LED WIDE H-11  
raw aluminium:  
500mm **under the order**  
1000mm **under the order**  
2000mm **016983**  
- anod.:  
500mm **under the order**  
1000mm **under the order**  
2000mm **under the order**



ending /set= 2pcs/  
**017328**



ending thickness increases the length of the profile

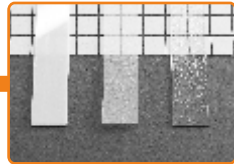

cover white	cover frosted	cover transparent
500mm	500mm	500mm
1000mm	1000mm	1000mm
2000mm	2000mm	2000mm
<b>017324</b>	<b>017327</b>	<b>017326</b>

### optional mounting:



holder simple  
/set = 2pcs/  
**017287**

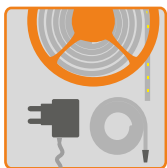

LED strip + cable  
+ power supply  
--> pages 21 - 24

### example applications



Cabinet lighting with cool white LED strip

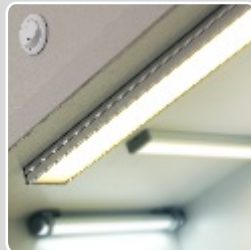

cabinet lighting with 3 LED strips warm white

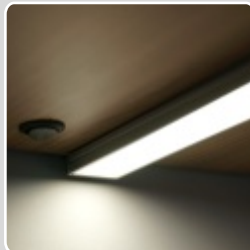

under cabinet lighting in the kitchen with 3 LED strips – first: warm white, the other: cool white

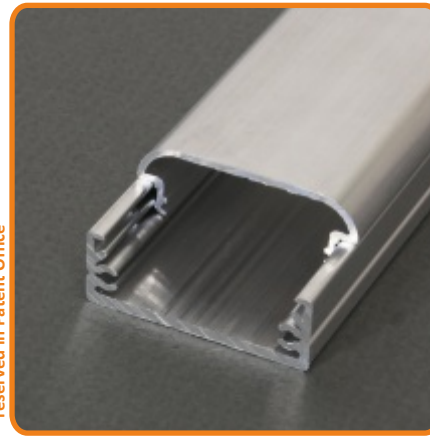

## profile LED WIDE H-11

universal mounting profile

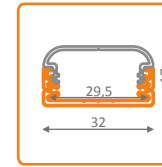

aluminium (optionally painted)

standard lengths: 500, 1000, 2000mm;  
max. length 4000mm; length above 2000mm - own collection

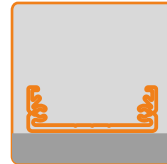

profile LED WIDE H-11  
raw aluminium:  
500mm **under the order**  
1000mm **under the order**  
2000mm **016983**  
- anod.:  
500mm **under the order**  
1000mm **under the order**  
2000mm **under the order**

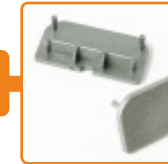

ending /set= 2pcs/  
**017331**

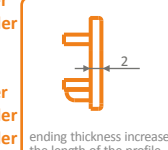

ending thickness increases the length of the profile

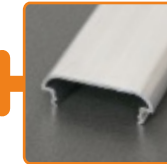

cover aluminium  
500mm **under the order**  
1000mm **under the order**  
2000mm **016982**

LED PROFILES

reserved in Patent Office

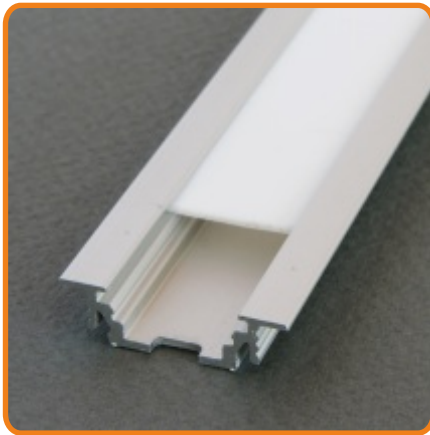

# profile LED GROOVE

the profile can be installed in the surface, furniture or tile gap, in the wall or ceiling; mounted directly or by a mounting plate

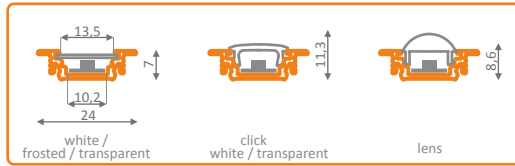

anodized aluminium

standard lengths: 500, 1000, 2000mm;  
max. length 4000mm; length above 2000mm - own collection

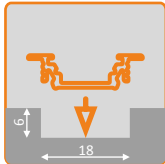

profile LED GROOVE  
anod.:  
500mm **under the order**  
1000mm **under the order**  
2000mm **017385**



ending /set= 2pcs/  
**017384**

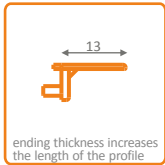

ending thickness increases  
the length of the profile

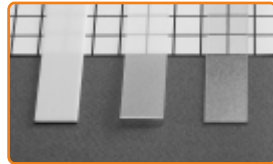

cover white

500mm

1000mm

2000mm

**017319**

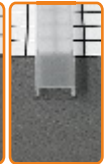

cover frosted

500mm

1000mm

2000mm

**017318**

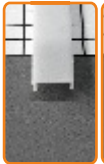

cover transparent

500mm

1000mm

2000mm

**017313**



cover click transparent

500mm

1000mm

2000mm

**017317**



cover click white

500mm

1000mm

2000mm

**017382**



cover lens

500mm

1000mm

2000mm

**017312**

### optional mounting:



mounting plate  
/set = 2pcs/  
**017379**



flexible mounting plate  
/set = 2pcs/  
**017378**

### optional connector



connector  
**017338**

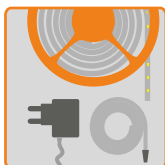

LED strip + cable  
+ power supply  
--> pages 21 - 24

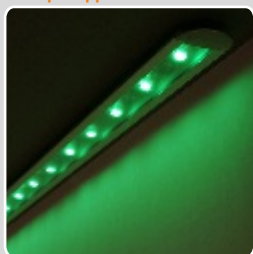

Cabinet lighting  
with RGB LED strip

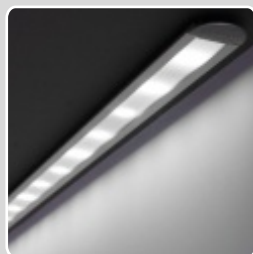

Cabinet lighting  
with cool white LED strip

reserved in Patent Office

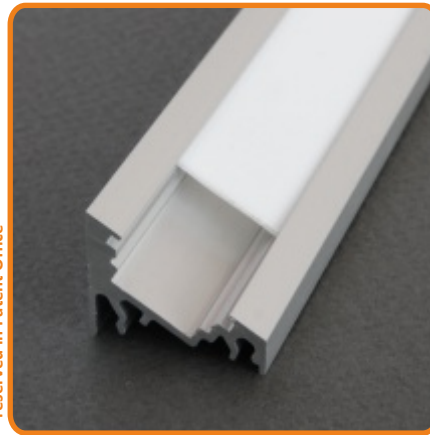

# profile LED CORNER-L30

Corner 30° or 60°, can be used as a lighting inside cabinets and cupboards; mounted directly or by mounting plate (2-4pcs/1m)

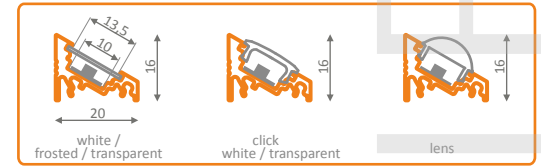

anodized aluminium

standard lengths: 500, 1000, 2000mm;  
max. length 4000mm; length above 2000mm - own collection



profile LED CORNER-L30  
anod.:  
500mm **under the order**  
1000mm **under the order**  
2000mm **017255**



ending /set= 2pcs/  
**under the order**

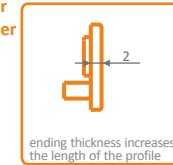

ending thickness increases  
the length of the profile

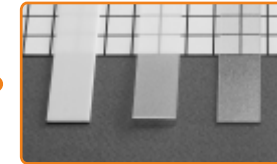

cover white

500mm

1000mm

2000mm

**017319**

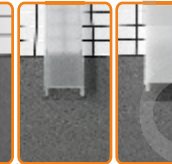

cover frosted

500mm

1000mm

2000mm

**017318**

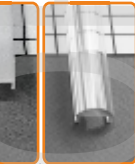

cover transparent

500mm

1000mm

2000mm

**017313**

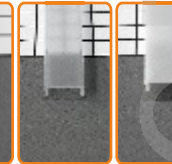

cover click transparent

500mm

1000mm

2000mm

**017317**

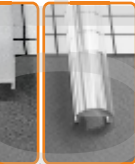

cover click white

500mm

1000mm

2000mm

**017382**



cover lens

500mm

1000mm

2000mm

**017312**

### optional mounting:



mounting plate  
/set = 2pcs/  
**017379**

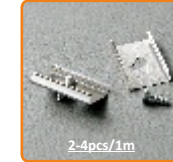

flexible mounting plate  
/set = 2pcs/  
**017378**



connector  
**017338**

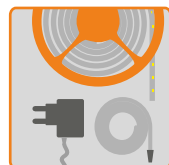

LED strip + cable  
+ power supply  
--> pages 21 - 24

### example applications



lighting behind TV drawer  
and exhibition on the shelf  
/TV room, DOMINICANS/

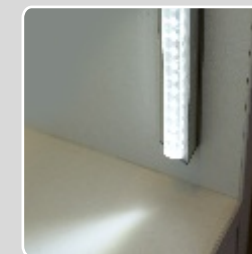

cabinet lighting with cool white LED  
and lens cover

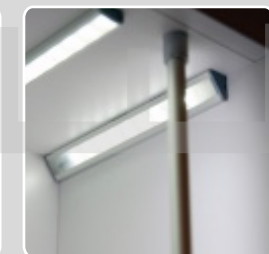

corner cabinet lighting  
with cool white LED strip

### beam angles depend on way of mounting:

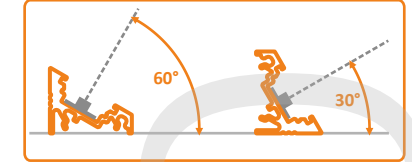





# profile LED SURFACE

can be used as lighting under cupboards, inside cabinets and cupboards; mounted on a flat surface directly or by mounting plate (2-4pcs/1m)

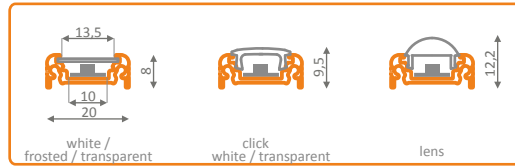

anodized aluminium

standard lengths: 500, 1000, 2000mm;  
max. length 4000mm; length above 2000mm - own collection

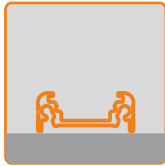

profile LED SURFACE  
- anod.:  
500mm **under the order**  
1000mm **under the order**  
2000mm **016974**



ending /set= 2pcs/  
**017330**

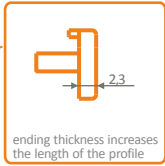

ending thickness increases the length of the profile

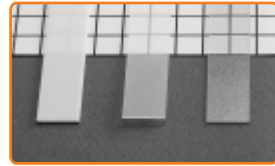

cover white

500mm

1000mm

2000mm

**017319**

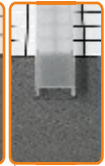

cover frosted

500mm

1000mm

2000mm

**017318**

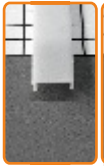

cover transparent

500mm

1000mm

2000mm

**017313**



cover click transparent

500mm

1000mm

2000mm

**017317**



cover click white

500mm

1000mm

2000mm

**017382**

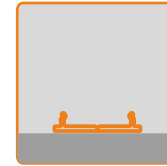

cover lens 60°

500mm

1000mm

2000mm

**017312**

### optional mounting:



mounting plate /set = 2pcs/  
**017336**



flexible mounting plate /set = 2pcs/  
**017339**



holder simple /set = 2pcs/  
**017284**



connector **017338**

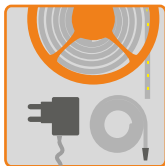

LED strip + cable + power supply  
--> pages 21 - 24

### example applications



bookcase lighting with different colors LED strips

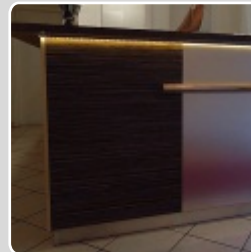

lighting under table top /ART-CON/

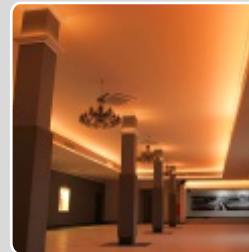

banquet hall lighting /ECOTECHNOLOGIES/

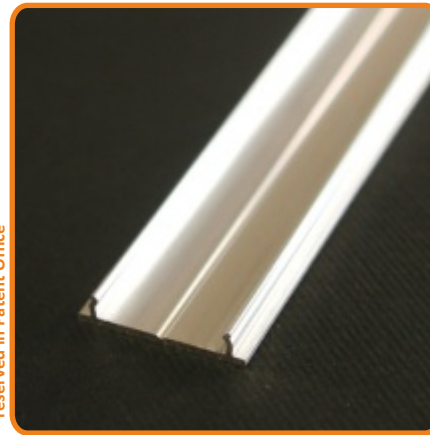

# profile LED FIX

for stiffing a LED strip or as a supplement of the profiles LED Surface, Corner, Groove

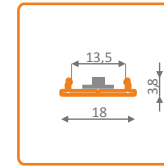

raw aluminium

standard lengths: 500, 1000, 2000mm;  
max. length 4000mm; length above 2000mm - own collection

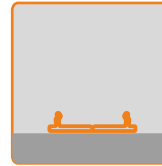

profile LED FIX - raw aluminium:  
500mm **under the order**  
1000mm **under the order**  
2000mm **016969**

### optional application

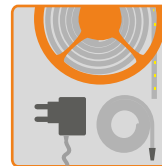

LED strip + cable + power supply  
--> pages 21 - 24

LED PROFILES

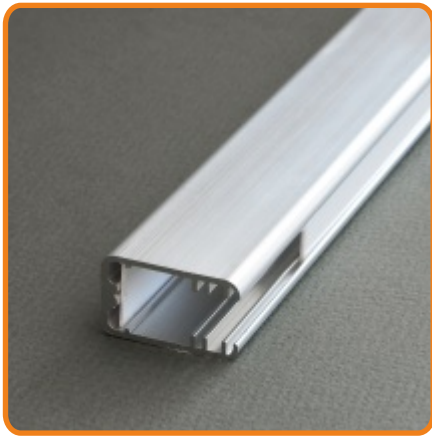

## profile LED SHELF9

the profile gives effect of lighting line;  
various mounting possibilities: flat, back, side;

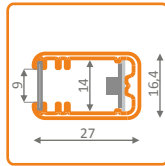

aluminium (optionally painted)

standard lengths: 500, 1000, 2000mm;  
max. length 4000mm; length above 2000mm - own collection

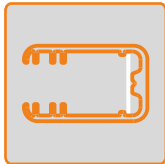

profile LED SHELF9  
- raw aluminium:  
500mm **under the order**  
1000mm **under the order**  
2000mm **under the order**  
- anod.:  
500mm **under the order**  
1000mm **under the order**  
2000mm **016977**



ending /set= 2pcs/  
**017334**

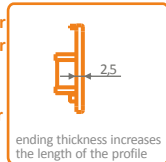

ending thickness increases  
the length of the profile

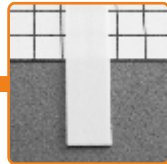

cover  
white

500mm **under the order**  
1000mm **under the order**  
2000mm **under the order**  
**017325**

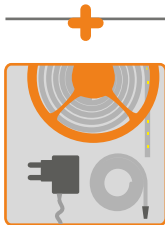

LED strip + cable  
+ power supply  
--> pages 21 - 24

### example applications

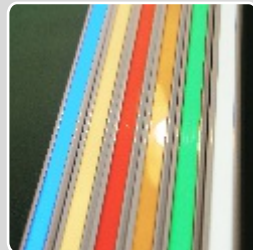

SHELF9  
with different colours of LED strips



lines mounted on the wall  
with different colours of LED strips



example profile with cool white LED strip

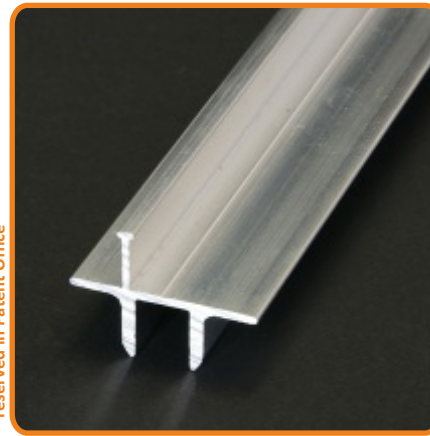

## profile LED GLASS8-2D

for lighting furniture back wall  
or optionally also the glass (max thickness 8mm)

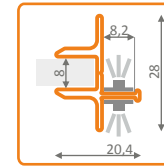

aluminium (optionally painted)

standard lengths: 500, 1000, 2000mm;  
max. length 4000mm; length above 2000mm - own collection

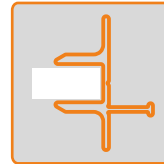

profile LED GLASS8-2D  
- raw aluminium:  
500mm **under the order**  
1000mm **under the order**  
2000mm **016976**

## profile LED GLASS8-3D with slots



profile LED GLASS8-3D  
- aluminium:  
500mm **under the order**  
1000mm **under the order**  
2000mm **016979**

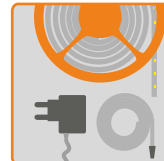
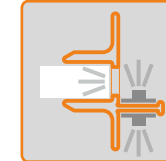

LED strip + cable  
+ power supply  
--> pages 21 - 24

### example applications



lighting of cabinet back wall  
/MATKOWSKI/

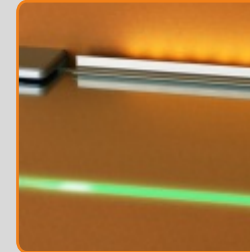

lighting of cabinet back wall with LED GLASS8-3D version

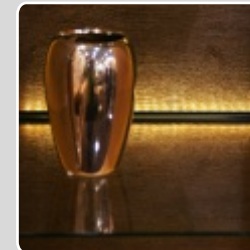

lighting of cabinet back wall  
/MATKOWSKI/

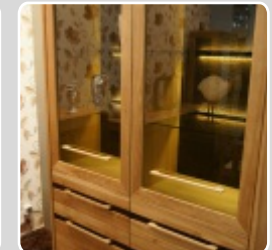

lighting of cabinet back wall  
/MATKOWSKI/

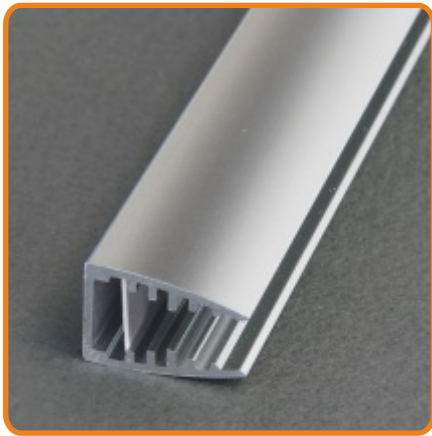

# profile LED SHELF6 for lighting a glass (thickness 6mm)

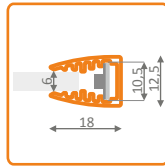

anodized aluminium (glossy)

standard lengths: 500, 1000, 2000mm;  
max. length 4000mm; length above 2000mm - own collection

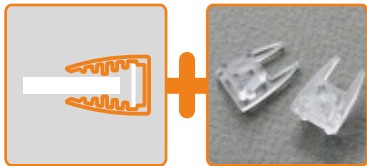

profile LED SHELF6  
- anod.:

500mm **under the order**  
1000mm **under the order**  
2000mm **016978**

ending /set= 2pcs/  
**017329**

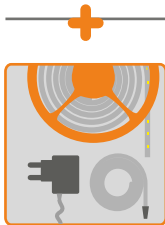
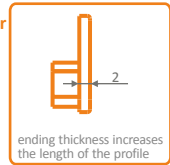

LED strip + cable  
+ power supply  
---> pages 21 - 24

### example applications



example piece ready for mounting and connection

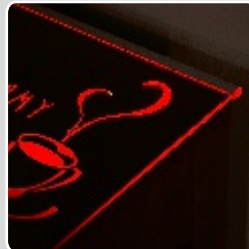

backlight of graphics on the glass top



glass lighting with blue LED strip



# profile LED SHELF9 for lighting a glass (thickness 5-9mm)

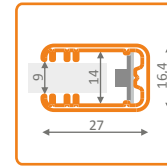

raw aluminium (optional painting) or anodized aluminium

standard lengths: 500, 1000, 2000mm;  
max. length 4000mm; length above 2000mm - own collection

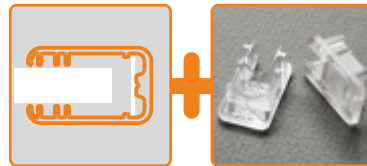

profile LED SHELF9  
- raw aluminium:

500mm **under the order**  
1000mm **under the order**  
2000mm **under the order**  
- anod.:

500mm **under the order**  
1000mm **under the order**  
2000mm **016977**

ending /set= 2pcs/  
**017335**

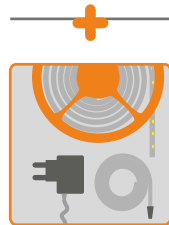
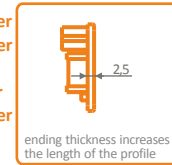

LED strip + cable  
+ power supply  
---> pages 21 - 24

### example applications

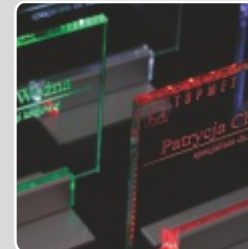

backlight of small desk plates with names

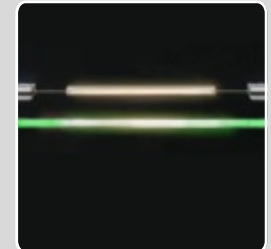

backlight of the glass with cool white LED strip

# LED STRIPS



LED strip  
cool white  
12V; 4,8W/m; 60P/m  
**010522**



LED strip  
warm white  
12V; 4,8W/m; 60P/m  
**010597**



LED strip  
blue  
12V; 4,8W/m; 60P/m  
**010523**



LED strip  
green  
12V; 4,8W/m; 60P/m  
**010520**



LED strip  
yellow  
12V; 4,8W/m; 60P/m  
**010521**



LED strip  
red  
12V; 4,8W/m; 60P/m  
**010526**

max length: 5000mm

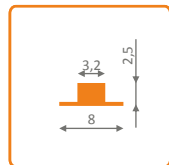

## others:

LED strip  
RGB  
12V; 7,2W/m; 30P/m  
**010596**

LED strip  
cool white  
12V; 7,2W/m; 30P/m  
**010595**

LED strip  
warm white  
12V; 7,2W/m; 30P/m  
**010594**

LED strip  
cool white  
12V; 9,6W/m; 120P/m  
**012334**

LED strip  
warm white  
12V; 9,6W/m; 120P/m  
**012335**

waterproof LED strip  
cool white  
12V; 4,8W/m; 60P/m  
**014627**

waterproof LED strip  
warm white  
12V; 4,8W/m; 60P/m  
**014795**

waterproof LED strip  
cool white  
12V; 9,6W/m; 120P/m  
**014637**

waterproof LED strip  
warm white  
12V; 9,6W/m; 120P/m  
**015730**

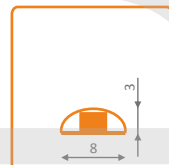
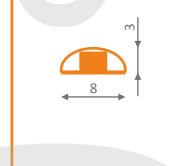
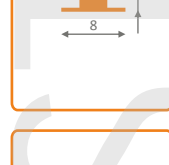
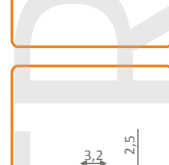
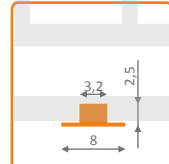
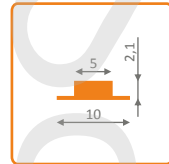

## PROFILES

- oval
- corner-VF
- surface
- groove
- corner-L30
- deep
- back
- slim
- wide-H11
- shelf9
- shelf6
- glass8
- pen
- fix
- swall
- shelf multi

## ENDINGS

- ending
- ending
- ending
- ending
- ending
- ending
- ending
- ending
- ending
- ending
- ending
- ending
- ending
- ending
- ending
- ending

## COVERS

- cover white/frosted/transparent
- cover lens transparent
- cover click transparent/white
- cover white/frosted/transparent
- cover white/frosted/transparent
- alu cover
- cover white
- glass 8-9 mm
- glass 6 mm
- glass 8 mm
- cover
- cover white/frosted/transparent
- cover narrow cover
- alu cover

## HOLDERS

- holder
- mounting plate
- flexible mounting plate
- two-sided adhesive tape
- connector
- two-sided adhesive tape
- flat holder
- others:
  - end
  - stretcher
  - jointed with thread
  - double with thread
  - jointed with ceiling
  - double with ceiling
- mounting plate flexible mounting plate
- holder wall bracket

## mini connector



4-way distributor box  
**016616**



6-way distributor box with cable 1500mm  
**016610**

## LED power supplies



LED power supply 5W  
• Pri: 170-264V~50/60Hz  
• Sec: 12V DC eff, 420mA  
• max load 5W  
• short circuit protection  
• size: 50x40x21mm

**014894**



LED power supply 15W  
• Pri: 220-240V~50/60Hz  
• Sec: 12V DC eff, 1,25A  
• max load 15W  
• short circuit protection  
• size: 123x45x19mm

**015763**



LED power supply 10W  
• Pri: 170-264V~50/60Hz  
• Sec: 12V DC eff, 830mA  
• max load 10W  
• short circuit protection  
• size: 102x39x20mm

**014889**



LED power supply SLIM 6W  
• Pri: 180-264V~50/60Hz  
• Sec: 12V DC eff, 500mA  
• max load 6W  
• short circuit protection  
• size: 98x45x10mm

**016117**



LED power supply SLIM 30W  
• Pri: 180-264V~50/60Hz  
• Sec: 12V DC eff, 2,5A  
• max load 30W  
• short circuit protection  
• size: 159x59x18mm

**016119**



LED power supply 60W  
• Pri: 220-240V~50/60Hz  
• Sec: 12V DC eff, 5A  
• max load 60W  
• short circuit protection  
• size: 180x52x30mm

**015761**

## LED contactless sensor switches



LED contactless door sensor switch  
12V/24W  
**016620**



LED contactless door sensor switch recessed  
12V/24W  
**016623**

*Светодиодное освещение  
лучшего качества в Украине*  
[www.arlight-group.com](http://www.arlight-group.com)

